



Manual

> INSTALLING NUTRIFLEX COMPASS



**Fertiliser dosing units**  
**NutriFlex Compass Substation**



# Contact

Priva (head office)  
Zijlweg 3  
2678 LC De Lier  
The Netherlands

See [www.priva.com](http://www.priva.com) for contact information of a Priva office or partner for your region.

Article number: 3790218  
Version: 00.003  
Date: March 2020

© Copyright Priva B.V. All rights reserved.

No part of this publication may be reproduced, published or stored in a retrieval system without written prior permission of Priva.

This publication has been developed with care. However, the products shown may differ in dimensions and design from the actual products. Priva will not accept any responsibility for damages caused by any errors or deficiencies in this publication. Priva may modify its products and the associated manuals without prior notice. Priva advises to check product, installation, hardware and if present software on irregularities.

Priva owns the patents, patent applications, trademarks or other intellectual property rights regarding the products described in this publication. With this publication Priva does not grant the use of the aforementioned intellectual property rights. Product and company names this publication may not be used without the permission of Priva.

All Priva products and services are subject to the relevant Priva general terms and conditions. These general terms and conditions can be read and downloaded at [www.priva.com/general-conditions](http://www.priva.com/general-conditions).

---

# Contents

About this manual .....	5
Aim and scope .....	5
Target groups and required competencies .....	5
Availability of the manual .....	5
Symbols in this manual .....	6
Safety .....	7
Safety - general .....	7
Safe handling of chemical substances .....	7
Electrical safety .....	8
Safety with mechanical parts .....	8
Safety with hot parts .....	9
Noise safety .....	9
Safeguards .....	9
Safety icons on the unit .....	10
Personal protective equipment .....	11
Product description .....	12
Functions and intended use .....	12
Preparing irrigation water .....	12
Correcting the pH value of irrigation water .....	12
Distributing irrigation water .....	13
Versions .....	13
Principle of operation .....	14
Construction .....	16
Controls .....	17
Pump switch .....	17
Main switch .....	17
Workplace .....	17
Type plate on the product .....	18
Warranty .....	19
Transport and storage .....	20
Transport .....	20
Conditions during transport and storage .....	20
Positioning the unit .....	22
Location and environmental conditions .....	22
Minimum free space around unit .....	22
Environmental requirements .....	22

---

Basic facility requirement .....	23
Positioning the unit .....	23
<b>Installation - hydronic part .....</b>	<b>24</b>
Installing the water supply .....	24
Installing the fertiliser and acid or lye supply .....	26
Fertiliser tanks and acid or lye tanks .....	26
Fertiliser filters .....	27
Fertiliser lines and acid or lye lines .....	27
Install the water distribution .....	29
<b>Installation - electrical part .....</b>	<b>31</b>
Cabinet layout .....	31
Compass substation cabinet .....	31
Cable entry .....	32
Connecting the power supply .....	33
Replacing fuses .....	34
<b>Parts .....</b>	<b>35</b>
Pump .....	35
Pump control .....	35
Technical specifications - pumps .....	35
pH interface .....	37
Connecting the pH interface .....	37
Technical specifications - pH-interface .....	37
pH sensor .....	38
Fitting the pH sensor .....	38
Calibrating the pH measurement .....	38
Cleaning the pH sensors .....	39
Technical specifications - pH sensor .....	40
EC-DSS interface .....	41
Operation of EC-DSS interface .....	41
Connecting the EC-DSS interface .....	41
Expanding the EC-DSS interface .....	42
Technical specifications - EC-DSS-interface .....	42
Connecting the Compass EC sensor .....	43
Specifications for EC sensor .....	44
EC sensor .....	44
Calibrating the EC measurement (Compass) .....	44
Cleaning the EC sensors .....	46
Technical specifications - EC sensor .....	46
Mixing tank low level switch .....	47

Checking the low level switch on the mixing tank .....	47
Control float .....	48
Adjusting the float control valve .....	48
Dosing channels .....	48
Types of dosing channels .....	48
Technical specifications - dosing channels .....	49
Inline dirt filter .....	53
Cleaning the inline dirt filter .....	53
Filter and rotameter dosing channel .....	54
Cleaning the dosing channel filter .....	54
Cleaning the dosing channel rotameter .....	55
Fertiliser suction .....	56
Checking the fertiliser suction .....	56
Dosage valves .....	56
Adjusting the dosing valve .....	56
Flow sensor .....	57
Connecting .....	57
Cleaning the flow sensor .....	57
Technical specifications – flow sensor .....	57
Technical specifications - T-piece for flow sensor .....	57
Filters .....	59
Filter types .....	59
Position of the filter relative to the unit .....	60
Operating software .....	61
Commissioning the dosing unit .....	62
User settings .....	63
Delivery to the user .....	63
Operation .....	64
Process phases .....	64
Turning the unit on and off .....	64
Emergency stop .....	65
Power supply failure .....	65
Topping-up fertilisers and acid or lye .....	65
Adjusting the user settings .....	66
Taking out of operation .....	67
Troubleshooting .....	68
Maintenance and repair .....	72
Preventative maintenance schedule .....	72

---

Setting the unit to maintenance mode .....	73
Levels of setting to maintenance mode .....	73
Cleaning the exterior of the unit .....	73
Updating the software .....	73
<b>Disposal of waste equipment .....</b>	<b>74</b>
<b>Appendices .....</b>	<b>75</b>
EC Declaration of Conformity .....	76
Technical specifications .....	77
Technical specifications - general .....	77
Technical specifications - mechanical .....	78
Technical specifications - electrical .....	79
Technical specifications - process computer .....	79
Technical specifications - screw coupling adaptation rings .....	81
Supply water quality .....	82
Preparing an acid supply .....	84
Terms and abbreviations .....	86

# About this manual

## Aim and scope

This manual contains all of the information required to safely and correctly transport, install, commission and maintain the fertiliser unit. This manual will also allow you to effectively observe and resolve any faults.

The data and the illustrations in this manual relate to the various models of the fertiliser unit. In addition, each fertiliser unit has customer-specific features, which may differ slightly from the description in this manual. You can find details about this in the project drawings and documents that have been created specifically for your delivery.

For the sake of simplicity this manual uses the term 'unit' to refer to 'fertiliser unit'.

## Target groups and required competencies

Target group	Tasks and responsibilities	Training, knowledge and experience required
installers / service engineers	do the following with the unit: <ul style="list-style-type: none"> <li>• transport</li> <li>• position</li> <li>• install</li> <li>• commission and set up</li> <li>• test after initial commissioning and problem solving</li> <li>• operate</li> <li>• annual check</li> <li>• take out of operation and dispose at the end of the service life</li> </ul>	<ul style="list-style-type: none"> <li>• technical training in the field of electrical engineering and process engineering</li> <li>• experience with water installations for the horticulture industry</li> <li>• Priva product specific training</li> <li>• knowledge of the characteristics and hazards of the chemical substances used in water installations</li> <li>• command of (technical) English</li> </ul>







## Availability of the manual







This manual is exclusively intended for installers and service engineers, not for users.

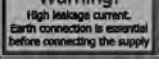



For employees who operate and monitor the unit, the operating manual and any other relevant manuals (such as the software manual of the process computer) must be available at the workplace.

## Symbols in this manual

The following symbols may appear on the unit and in the manuals.

Warning symbols for specific hazards	
	danger: read the manual before switching the unit on
	corrosive chemical substance(s)
	hot surface
	live parts (danger of electrocution)
	UV light
	oxidising chemical substance(s)
	High leakage current! Earthing required for the connection of the power supply.

Prescriptive symbols	
	wear ear protection
	wear safety glasses
	wear ear protection and safety glasses
	wear non-permeable gloves that are resistant to chemical substances
	wear clean work clothes that cover as much of the skin as possible
	wear (safety) boots
	Read the device manual

Other symbols	
	danger (instruction to prevent physical injury, damage to health or damage to the environment)
	note (instruction to prevent problems or material damage)
	additional information or explanation
	tip



## Safety



- Before starting to work with the product, read the entire manual so that you are familiar with all safety instructions and safety precautions.
- In addition, read any other manuals supplied with specific components.

### Safety - general

- Only Priva approved installers/service engineers who have received product-specific training from Priva are allowed to install, configure, repair and, if necessary, alter the product.
- Making alterations to the safeguards and safety icons on the equipment is prohibited.
- The internal connections are made in the factory and are to a large extent customer-specific (refer to the supplied project drawings). Do not, therefore, alter the internal connections.
- External equipment or components that are connected to the unit, such as computers and networks, must comply with the relevant electrical isolation safety regulations.
- Both the installer/service engineer and the user must regularly check and maintain the equipment (the safeguards in particular) in accordance with the instructions in this manual. Keep the equipment clean and the surroundings tidy.
- Report malfunctions or damage to your installer immediately. Take the equipment out of operation and do not use it if a defect is found.
- Only use original spare parts for repairs (refer to the spare parts price list).
- After making repairs check the correct status and functioning of the equipment.
- If the user allows personnel to operate the equipment, he/she must adequately instruct this personnel. In particular this should cover the safety risks and safety instructions stated in this manual. He/she must also supervise correct compliance with the instructions.
- Ensure that the personal protective equipment prescribed in this manual is available and that it is used.
- Display the safety icons that are applicable in the room where the equipment is set up.

### Safe handling of chemical substances



When working near or on equipment for chemical substances (such as tanks, lines and dosing channels) there is a danger of contact with concentrated fertilisers and acid or lye. These chemical substances can be caustic and corrosive, so they could cause damage to the eyes and skin and damage to equipment. The unit suctions up the liquids and mixes them with water. Once correctly mixed and at the correct pH there is almost no danger to health or safety under normal use.

Ask the supplier of the chemical substances for detailed safety information. Ensure that everyone working with or near the chemical substances is aware of the following:

- the names of the substances and the concentrations;
- the risks;
- the protective measures required;
- action to be taken in the event of contact with the skin or eyes or after inhalation or ingestion;
- action to be taken in the event of leaks.

The following safety precautions apply for working with chemical substances:

- Ensure that the tanks and lines are positioned and installed correctly in accordance with the applicable local regulations.
- Provide a facility for collecting and disposing of leaked chemical substances. Place, for example, the unit and tanks in a concrete structure that is large enough to contain the entire volume in the event of leaks.

- Set the components up in such a way that they cannot easily be damaged.
- Ensure the dilutions are correct and use materials that are resistant to chemical substances.
- Clearly mark tanks and lines with the substances they contain.
- Ensure that the room is well-ventilated.
- Wear safety glasses, safety gloves and (safety) boots that are impervious to chemical substances. Wear clean work clothes that cover as much of the skin as possible.
- Ensure that there are facilities for showering and bathing the eyes near at hand. Ensure that everyone understands where these facilities are and how to use them. Ensure that the facilities are working at all times and are clean. Regularly rinse eyewash fountains in particular to prevent bacterial pollution.
- Remove clothing immediately if it has been contaminated with chemical substances. Wash the skin and the clothing with copious amounts of water.
- Ensure that the telephone number of professional emergency services is known in case that service is required. Notify the emergency services of which substance is involved in the event of an accident.
- Ensure that facilities for collecting leaking chemical substances, cleaning them up, diluting them with water and rinsing them away are always close to hand.
- Never add water to concentrated substances – add the concentrated substance to the water! This keeps the consequences of the reactions (gas formation, heat generation, effervescence, splashing) to a minimum.
- Empty the equipment and lines and/or rinse them thoroughly with water before opening them for maintenance.
- Drain discharge water - if not reused - in accordance with the locally applicable environmental regulations.

## Electrical safety



The unit is powered from the mains voltage. There is a potential hazard of electrocution or fire resulting from a short circuit. You must therefore adhere to the following safety instructions:

- Keep the housings of electrical components closed.
- Keep the electrical parts dry.
- Make sure that the earthing is connected correctly.
- Ensure that the unit is connected to its own fuse group with the correct fuses.
- The electrical connection must comply with the locally applicable regulations.

During installation, maintenance or while resolving faults it may be necessary to open the housing for the electrical components. In this case, adhere to the following safety instructions:

- Preferably, make the unit totally free of electricity by removing the plug from the socket outlet or by removing fuses from the fuse group.
- If the unit cannot be made free of electricity then take extreme care. Use well-insulated tools and do not touch the ends of wires, connections and electrical components with your bare hands. Keep the surroundings dry and ensure that there is someone close by to keep an eye on you.
- Wear an earthed wrist strap when working in the cabinet. Otherwise the electronic components may be damaged due to static electricity.

## Safety with mechanical parts

Adhere to the following safety instructions to prevent injury from mechanical causes:

- Transport and position the unit in accordance with the instructions in the (installation) manual. The unit is heavy!
- Install lines in such a way that no one can trip over them. Keep the surroundings tidy and dry to prevent trips and slips.
- Keep the housing of the pump(s) closed.

Take measures to prevent water hammer to avoid damage to equipment. Fill lines gradually and bleed them before switching the pumps to full operation or fully opening main valves.

## Safety with hot parts



Parts of the unit that may become hot are equipped with this sticker.

Do not touch these parts during or shortly after operation.

## Noise safety



Especially the pump(s) and the filling valve produce noise when the unit is in operation. The emission sound pressure depends on the configuration selected and can rise to 85 dB(A) at the workstation (measured according to ISO 3747:2010 for a NutriFlex with a Grundfos CR64 system pump and a ditto supply pump. Given the dimensions of the unit, this emission sound pressure represents a sound power level of 99 dB(A)). Wear hearing protection, certainly for long stays in the room or if there are more noise-emitting equipments in the same room.

## Safeguards

The unit has the following safeguards:

- The cabinet containing electrical components is closed with a locked door.
- The electric motors of the system pump and the supply pump (if present) are shielded by a ventilating cover.
- The motor protection switches the system pump or supply pump (if present) off if it is consuming too much current due to overloading. The process computer detects this situation and then shuts down the entire unit.
- The power supply of the modules in the cabinet is connected to a circuit breaker that removes the power if overloading occurs.
- The hot parts of the dosage valves are protected by a transparent, L-shaped plastic sheet.



**Shielding on a dosage valve**

- In the version with a 850 l mixing tank, there are holes in the neck of the tank to prevent the tank from coming under pressure in the event of the water supply failing to stop in time on account of a defective control float/filling valve. This is because this version has a screw cover, which cannot be lifted off the tank by excess water.



- Install and use the equipment in accordance with the instructions in this manual to ensure that the safeguards function correctly.
- Never bridge or remove the safeguards: this can lead to a serious accident.

## Safety icons on the unit

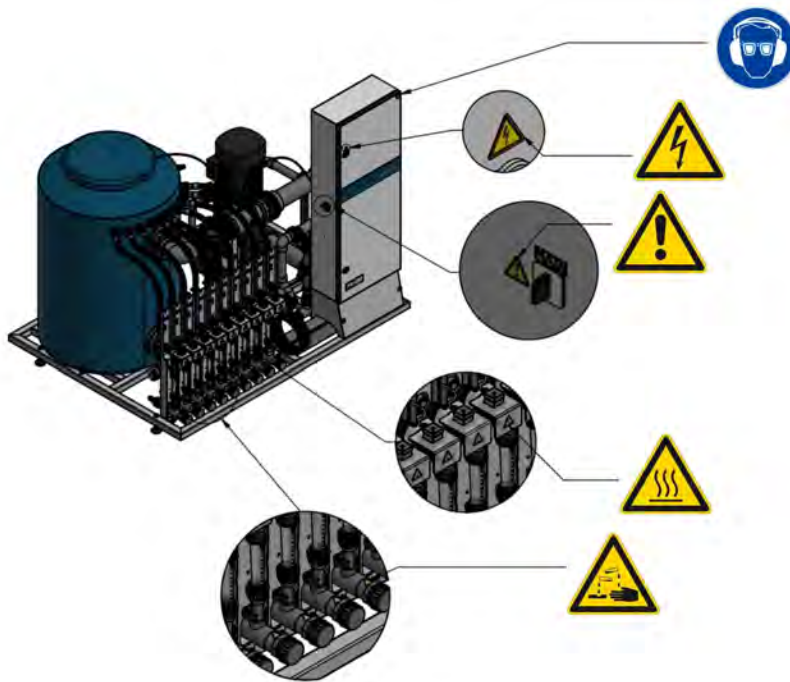

Ensure that the safety icons are clearly legible at all times. Replace any stickers with the safety icons which have become illegible.

---

## Personal protective equipment

When working on the unit, tanks and lines always wear the following protective equipment to prevent injury or damage to your health:



# Product description

## Functions and intended use

The fertiliser unit provides irrigation water for horticulture. To this end, the unit has the following functions:

- preparing irrigation water;
- correcting the pH value of irrigation water;
- distributing irrigation water.

The unit can perform these functions simultaneously.

## Preparing irrigation water



Only use the unit to dose diluted fertilisers for plant cultivation that are dissolved in water. The fertiliser solutions must be available in fertiliser tanks. The dilution must be such that it contains no sediment or pollution.

The unit mixes the fertilisers from the fertiliser tanks with supply water in the required ratio to form a homogeneous irrigation water with the correct EC value. This can be done according to 2 principles:

- A+B principle: fertiliser solutions are prepared (manually) in 2 (or possibly more) fertiliser tanks, in such concentrations that the unit must mix them in more or less equal amounts. In principle, the fertiliser tanks must also always be topped up at the same time. The levels may fall at different rates as a result of inaccuracies. Depending on the version, a balance level control is available to remedy this.
- ABC principle: the unit mixes the fertiliser solutions from the various fertiliser tanks in the ratios as programmed in the recipe. Whenever a fertiliser tank becomes empty this tank will have to be topped-up.

The concentration of a fertiliser solution is usually such that approximately 1 litre must be dosed per 100 litres of supply water. The capacity of the unit is determined by the capacity of the system pump, which in turn must match the capacity of the dosing channels.

Depending on the version, certain versions can mix drain water with fresh water based on the EC value (EC pre-control) or mix sources of fresh water in the desired flow rate ratios.

## Correcting the pH value of irrigation water

The unit brings the pH level of the irrigation water to the desired level. One of the dosing channels has to be used to dose acid or lye for pH correction, depending on the fertilisers and the pH of the supply water.



- Nitric acid is generally used for the pH correction. In principle, phosphoric acid or sulphuric acid can also be used, but this may cause calcium phosphate or calcium sulphate sediment. Moreover, there is a greater risk of a deviating fertiliser composition, especially with phosphoric acid. Nitric acid does not have this drawback. For this reason, Priva recommends nitric acid as the acid for correcting the pH.
- Various acid channels are possible, depending on the maximum acid concentration:
  - up to 3% (weight percent), a dosing channel with rotameter is possible.
  - up to 10% (weight percent), a dosing channel without rotameter is possible.
  - up to 38% (weight percent), a dosing channel <38% acid is possible.

## Distributing irrigation water

The unit distributes the irrigation water to the crop. This can be done in 2 ways:

- Direct distribution: the unit transports the irrigation water directly to the crop area. To do this the unit pressurises the distribution system. Then the control software opens the irrigation valves according to a specific program and controls the quantity of irrigation water. Irrigation systems, such as overhead irrigation systems, drippers and ebb and flow systems on containers and tables are possible depending on the design. In this application the unit is only active during irrigation.

The cultivation area that can be irrigated with one unit depends on the crop and the chosen combination of system pump and dosing channels.

- Indirect distribution: the unit supplies the irrigation water to a stock tank or silo for a period of 24 hours, for example. From there, a separate pump supplies the irrigation water to the distribution system. This pump and the irrigation valves are not controlled from the unit. With this method, in comparison with the direct method, a simpler design will be adequate with a smaller system pump while a larger crop area can be supplied with irrigation water. Complex systems with multiple stock tanks for different recipes and intelligent water management can be realised depending on the process computer that has been selected.



For critical crop conditions and large crop areas it is recommended to install a spare unit. This reduces the risk of insufficient irrigation water being available in the event of a malfunction, which could result in damage to the crop.

The irrigation water prepared in accordance with the recipe is distributed immediately. If the distribution stops - for whatever reason - the EC control and pH control automatically ensure that dosing of fertilisers and acid (or lye) also stops.

## Versions

The NutriFlex is delivered as a substation. This means that the unit does not have a built-in process computer and must therefore be controlled by an external Priva process computer (Connex or Compass). This computer generally also has other tasks, such as climate control, energy management and CO<sub>2</sub> dosage. The Substation version does not come with a display or keyboard as standard.

You can choose: the type of supply pump (optional), the type of system pump, the type of mixing tank (300 l or 850 l), the control of the pump(s) (via magnetic switch or softstarter), the number of dosing channels and the types of dosing channels. For more details about the possibilities, see the technical specifications and the price list (for dealers).

## Principle of operation

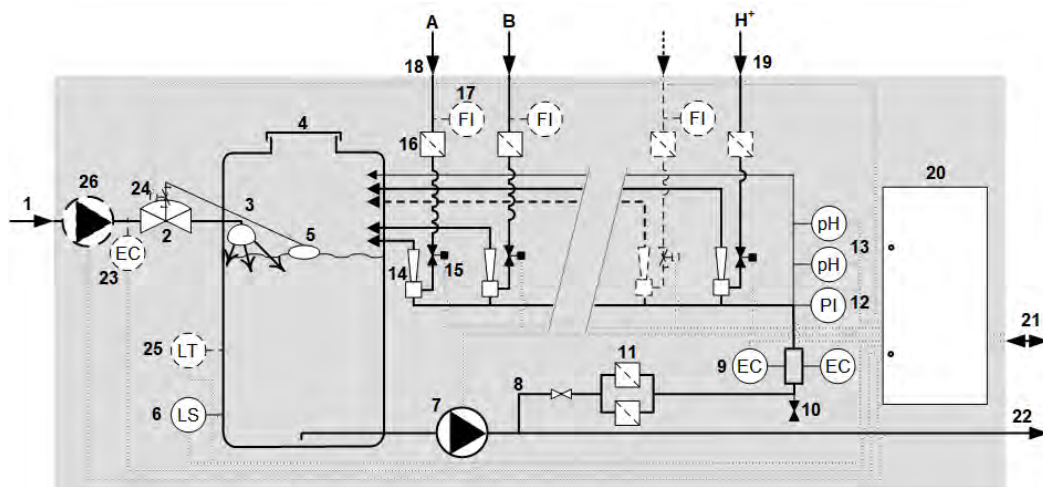

**Graphic of NutriFlex fertiliser dosing unit**

(The components within the grey area are supplied as standard. The components shown with a dashed line are optional. The electrical cables are drawn with a dotted line.)

### Water supply and mixing tank

The supply water line (1) is connected to the filling valve (2) of the mixing tank (4). The control float (5) controls the filling valve and ensures that the mixing tank remains full. The supply water flows into the tank via the spray head (3), so that water and fertilisers are homogeneously mixed at the top of the tank.

Optionally, a supply pump (26) and an EC sensor for EC pre-control (23) can be installed on the unit.

The mixing tank is equipped with a low level switch (6) which ensures that the system pump (7) stops if the supply of water stagnates and there is a risk of the pump running dry. For the optional 'Mixing tank level reduction' process phase, a level sensor (25) and an electric valve (24) for closing the filling valve can also be installed. The 300 l mixing tank has a removable cover that does not close hermetically, so that vapours can escape and air can flow freely in and out. With capacities greater than approximately 65 m<sup>3</sup>/h, the exposure time in the tank would be too short, especially if there was a large amount of bicarbonate in the water. For such capacities, a 850 l mixing tank is therefore possible, with a screw cover and holes in the neck for bleeding.

### System pump and branch with dosing channels

The system pump pumps the irrigation water from the mixing tank to the crop (22) and pumps a small amount to the branch (8). On this branch there are a hand valve, two inline dirt filters connected in parallel (11), 2 EC sensors (9), a drain point (10), a manometer (12) and 2 pH sensors (13).

The water in the branch line (drive water) flows through the venturis of the dosing channels (14). The nozzles in the venturis create a vacuum that draws in the fertilisers (18) and acid or lye (19). Dosage valves (15) are installed in the fertiliser, acid or lye lines just before the venturis. The control software pulses the dosage valves to control the open time, based on a recipe and EC and pH measurements. The time that the dosage valves are open and closed determines the flow of fertiliser, acid or lye that is dosed on average.

The branch has 5 or optionally 10 connections for dosing channels. Not all of the connections have to be used. Unused connections can be fitted with a dosing channel at a future time, if needed.

### Fertiliser filters and rotameters on dosing channels

A dirt filter (16) may be installed in the fertiliser line of the dosing channel. A rotameter (17) can also be fitted, with which the fertiliser suction can be checked and, if necessary, the dosage valve can be adjusted. Rotameters are generally not used in dosing channels for acid solutions, because the acid damages the transparent tube.



## Special types of dosing channels

A dosing channel for acid or lye may be identical to a dosing channel for fertilisers. When using concentrated acid or lye, however, the flow of acid or lye is (much) smaller than with fertilisers. For this reason, you can also choose a 38% acid dosing channel for acid or lye. A different type of dosage valve and other materials have been used in this.

For fertilisers and other chemical substances for which a small flow (less than 8 l/h) is required, low-volume dosing channels are available. These dosing channels also work in the same way as the other dosing channels, but are equipped with a different type of dosage valve with a specific dosing restriction, do not have a filter and are constructed from different materials.

If it has to be possible to choose between two fertiliser tanks for each dosing channel, double dosing channels may be used. These consist of two dosing channels next to each other (which also occupy two dosing channel positions) with one joint venturi, with the fertiliser tank being selected by activating either the left-hand or right-hand dosage valve. The advantage of a double dosing channel over two single dosing channels is that you only need one venturi, which reduces the purchase costs. In addition, less drive water flows through the system.

## Inline dirt filter and manometer on branch

The inline dirt filters (11) in the branch prevent clogging of the venturi nozzles in the dosing channels. The dosing channels can be emptied via the drain point (10), e.g. for maintenance or if the unit will be out of service for a long time on account of a period of frost.

The manometer (12) on the branch enables a visual check of the drive water pressure.

## EC and pH sensors

The electrical conductivity of the irrigation water is an indirect measure of the fertiliser concentration and is measured using EC sensors (9). The pH sensors (13) measure the pH value of the irrigation water. The pH sensors are located in a sensor holder that is connected to the branch with a thin line, so that the measurement takes place at the correct pressure and speed.

By using 2 EC sensors and 2 pH sensors, the control software can compare the measured values of the 2 sensors. If one of the two sensors is not working (correctly), the measured values will differ too greatly from each other and the control software can activate an alarm.

## Cabinet

Depending on the version, the cabinet (20) contains the connections (21) for the mains power supply, valves, pumps and sensors.

## Construction

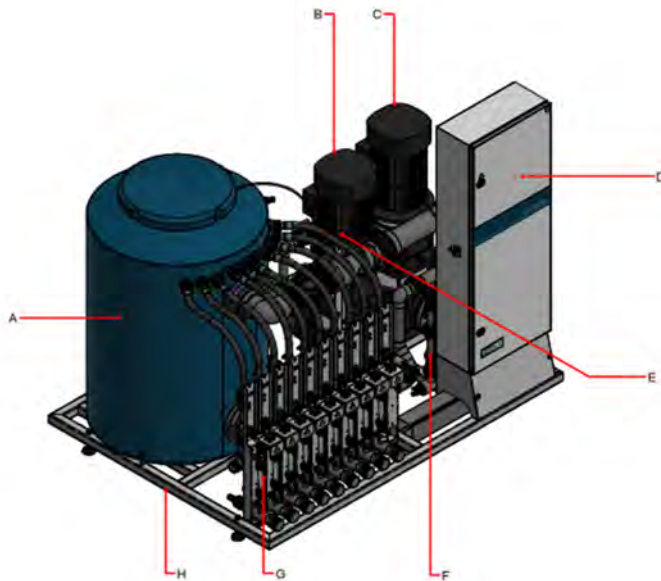

### **Front of NutriFlex (with 300 l mixing tank)**

- A. mixing tank
- B. system pump
- C. supply pump (optional)
- D. cabinet
- E. manometer
- F. EC sensors
- G. dosing channels
- H. frame with adjustable legs

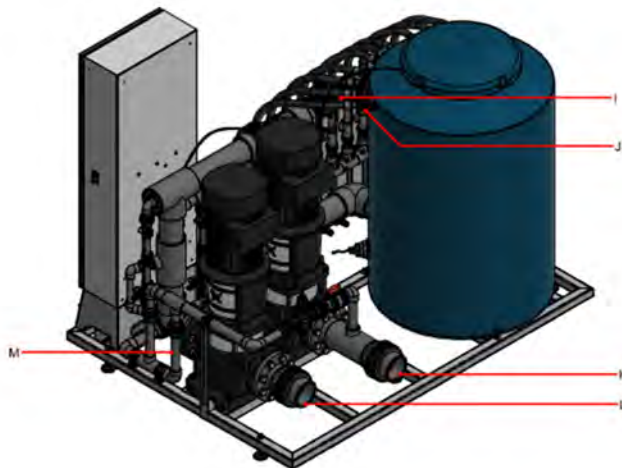

### **Rear of NutriFlex (with 300 l mixing tank)**

- I. pH sensors
- J. filling valve
- K. line from control float
- L. connection for main irrigation line
- M. connection for supply line
- N. dirt filters



The structure of the NutriFlex 850 is comparable, but the 850 version has a black mixing tank and different dimensions.

## Controls

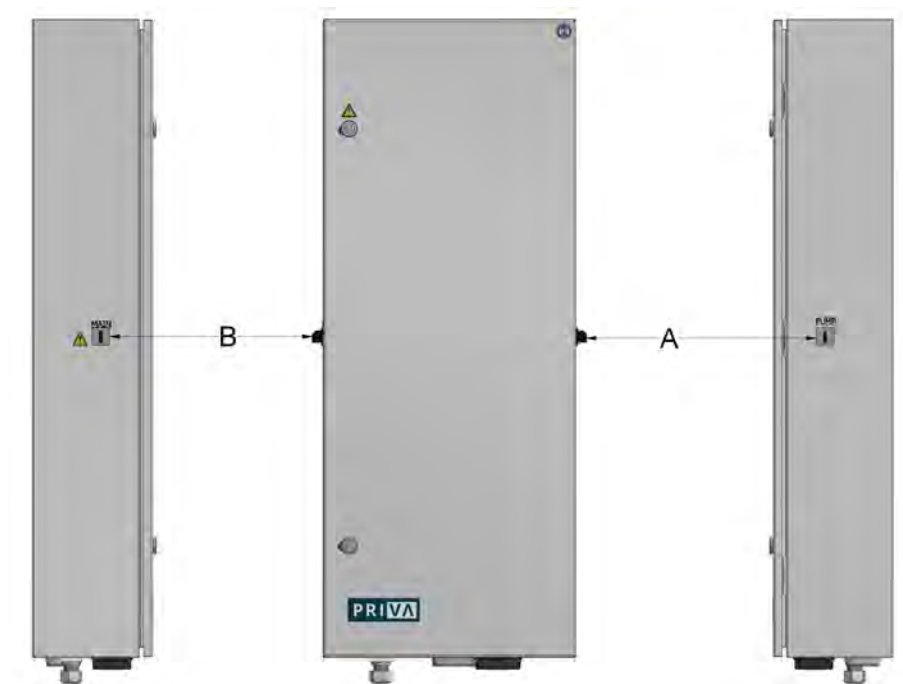

A. system pump switch ('pump switch')  
B. main switch

### Pump switch

The pump switch has the following positions:

- *Off*: the pump is off and cannot be switched on by the process computer
- *Manual*: the pump is on and cannot be switched off by the process computer
- *Automatic*: the pump is controlled by the process computer



The 'low level' protection in the mixing tank will be switched off when the system pump is operated manually. The pump will therefore continue to be on even when the mixing tank has been pumped dry. Therefore, switch the pump off in good time so that it does not run dry.

### Main switch

The main switch has the following positions:

- *Off*: no electrical power is being supplied to the unit
- *On*: electrical power is being supplied to the unit

## Workplace

After the unit has been commissioned, it works autonomously. As a result, there is no specific workplace. For maintenance, checks and alterations of setup changes (for a unit with a local operation panel) the unit must remain accessible from all sides.

## Type plate on the product



### **Location of the type plate**

(the type plate shown here is for recognition purposes and its details may differ from the type plate on your product)

The type plate on the product contains the following information (form top to bottom and from left to right):

- Product name and type designation
- *Serial No.*: serial number
- *Year*: year of construction
- *Connection*: specification of the connections to the mains voltage
- *Mains*: required mains voltage in VAC
- *Frequency*: required mains frequency in Hz
- *Power*: nominal power consumption in kW of system pump and any supply pump
- Name, address and web address of the manufacturer (Priva B.V.)
- Manual icon
- CE mark

## Warranty

The warranty expires if the product is not installed, used and maintained in accordance with the instructions in the Priva manual. For more details refer to the general terms of delivery (Priva will supply these on request and refer to [www.priva.com](http://www.priva.com)) and the specifically agreed terms of delivery.

## Transport and storage

### Transport

The unit is mounted on a wooden pallet.

The unit is protected by a wooden casing or heavy cardboard for transport. Use a fork-lift truck or pallet transporter to move the pallet with the unit.

Observe the following safety instructions during transport:

- Only drive a fork-lift truck if you are authorized to do so.
- Ensure that everyone involved in transporting the unit observes the generally applicable safety transport regulations.
- Lift the unit using a fork-lift truck only. Do not use a hoist or crane.
- Check that the fork-lift truck is suitable for the dimensions and weight first.
- Do not move the unit while it still contains liquids.
- Insert the forks of the fork-lift truck in the correct place and a sufficient distance under the pallet (refer to figure) and take the (eccentric) location of the centre of gravity into account.
- Make sure the load cannot slide during transport.

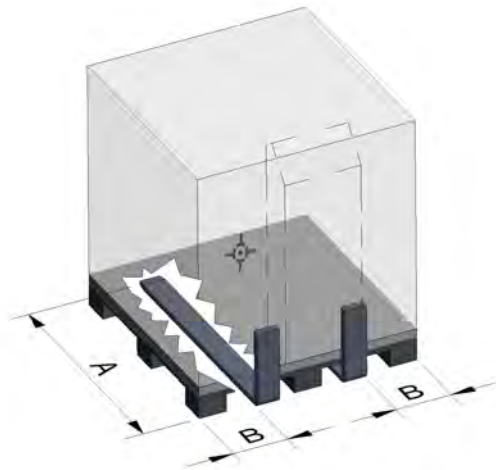

#### ***Passage for the fork-lift truck***

A = 120 cm = minimum fork length under the pallet

B = 20 cm = maximum distance between the side of the fork and the side of the pallet

The centre of gravity is indicated by the following symbol:



### Conditions during transport and storage

The ambient conditions must remain within the following limits during transport and storage:

- Temperature: 0 - 35°C.
- Relative air humidity: maximum 95% (non-condensing).
- Rain: the packaged equipment must be kept dry and must not, therefore, stand outdoors.
- Sunlight: the packaged equipment must not stand in bright sunlight. Otherwise, the internal temperature may become too high causing deformation in the plastic components.
- Vibrations: avoid exposure to strong vibrations.



The pH sensors are a sensitive part of the unit. As long as a pH sensor is not used, it must be stored with the glass membrane in 3.8 M KCl solution. This solution is in the cap of the pH sensor bottle. Never use distilled or demineralised water for storing the pH sensor and keep the pH sensors frost-free.

# Positioning the unit

## Location and environmental conditions

### Minimum free space around unit

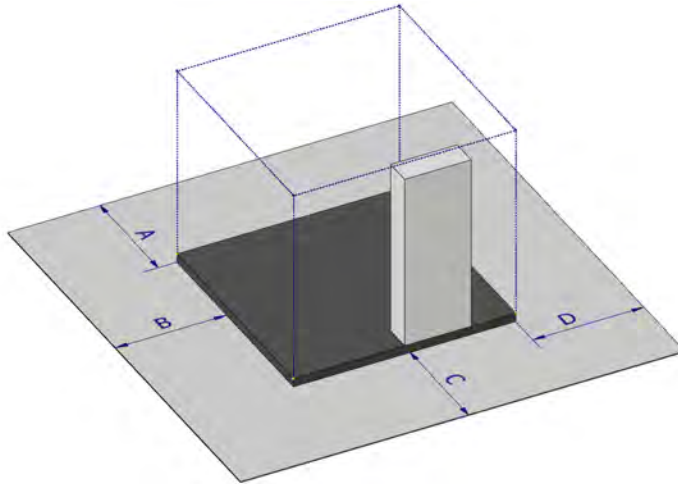

A = minimum 50 cm  
B, C, D = minimum 80 cm

### Environmental requirements



The unit must not be in direct sunlight. Due to bright sunlight the temperature will become too high, causing plastic parts to deform, creating malfunctions in electrical components and shortening the service life of electrical components. Always keep any cabinet ventilation grilles free and open, allowing the electrical components to be cooled.

General	Position the unit in an indoor, well-ventilated room, free from drips and splashes, with a stable temperature (no rapid temperature changes). Select a location where the unit cannot easily be damaged (e.g. by mobile equipment). The surface on which the unit will stand should be hard, flat and level.
Temperature when not operating	0 - 35°C As long as the unit contains water (residue) it must be kept frost-free.
Temperature during operation	5 - 30°C
Supply water temperature	5 - 30°C (the unit can still work at a maximum temperature of 30°C. However, with regard to the water quality and/or the operation of the unit, such a high water temperature is generally unacceptable.)
Relative air humidity	< 85% (this is lower than the maximum relative air humidity during transport because of the presence of chemical substances.) Condensation will form on the pipe-work, particularly when relatively cold supply water is used. This is very corrosive when combined with the vapours from the chemical substances. Hose clamps and other metal parts must therefore be of corrosion-resistant types of metals or must be well coated (and remain so). The cabinet contains sensitive electronic circuits and must definitely remain condensation-free.
Maximum installation height	1000 m above sea level (Cavitation may occur in the system pump when the ambient pressure is too low.)
Pollution factor (NEN-EN-IEC 61010-1)	maximum 2 (normal, non-conducting pollution)



## Basic facility requirement

A number of basic facilities must be present in the room before positioning and installing the unit:

- There must be a facility for collecting and disposing of chemical substances in the event of leakages, for instance a concrete tank in which the fertiliser and acid or lye tanks and the unit can be placed or a sloping floor with a drain pit. The tank or pit can be connected to the sewer by a valve, which is normally closed. If a disaster occurs, a decision can be taken as to whether the tank or pit can be discharged into the sewer with dilution water.
- There must be a sufficient supply of water at the right pressure. The water can comprise various sources, such as tap water, drain water, rain water, well water and river water.
- A separate electrical connection must be installed in accordance with local regulations. In doing so, also take into account any other devices that may be part of the system.



It is strongly recommended that an emergency stop is provided which makes all electrical equipment in the system free of electricity simultaneously. Position the emergency stop close to the unit.

- There must be a sufficient number of wall sockets for connecting tools and equipment during installation and maintenance.

Additional facilities may be required, depending on the quality of the supply water:

- Mechanical pretreatment using a filter to prevent blockages due to the sedimentation of solid particles in the system (see [Filters \(page 59\)](#)).
- Thermal conditioning using a heat exchanger if the temperature of the supply water is too low. Heating the water prevents condensation from spreading into the electrical components (such as the EC sensor connections). In addition, heating reduces the chance of precipitation of fertilisers.
- Chemical pretreatment by acidification of the supply water if the water contains too much bicarbonate (see [Supply water quality \(page 82\)](#)).
- Disinfection using UV light, optionally combined with dosage of hydrogen peroxide (Priva Vialux disinfection units). This is necessary in the event of the recycling of drain water and the use of dirty surface water.

In this manual it is assumed that the unit will be installed at the same time as the fertiliser tanks and the distribution system. The description of this, however, falls outside the scope of this manual.



The following facilities must also be present before the system is allowed to be filled with fertilisers:

- personal protective equipment;
- a shower (preferably a special emergency shower to rinse-off leaked chemical substances);
- an eyewash fountain;
- a fire hose to dilute and rinse away leaked chemical substances;
- safety icons on the access door(s) to the room.

## Positioning the unit

1. Carefully remove the casing and packaging so that unit is not damaged.
2. Remove the wooden pallet.
3. Position the unit on a hard, level surface inside the containment for collecting chemical substances in the event of leakage.
4. Level the unit using the feet on the frame.

## Installation - hydronic part

-  Only Priva approved installers/service engineers who have received product-specific training from Priva are allowed to install the unit.
-  For the purpose of the unit's screw couplings Priva supplies various adapter rings and imperial adapter rings that can be connected to the metric and imperial pipe diameters (refer to specifications and the price list).

### Installing the water supply

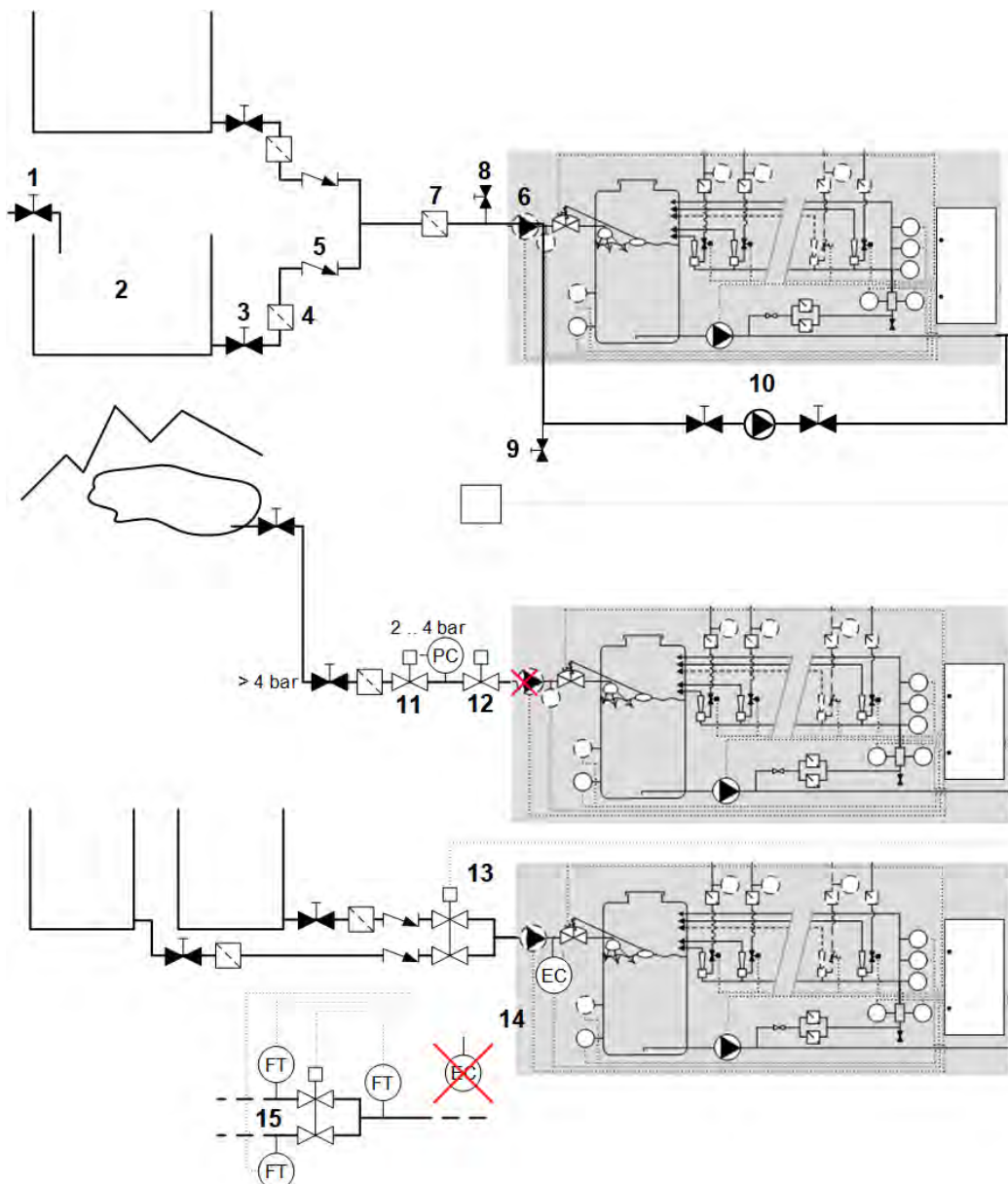

The figure merely illustrates the possible components. The actually required components depend on the desired configuration.

Attention should be paid to the following when installing the water supply:

1. **Connection**  
Never connect a drinking water line (1) directly to the water supply of the unit. Instead, allow drinking water to flow under atmospheric pressure into the supply water basin, tank or silo (2) or use a separate 'break tank'.
2. **Tank outlet**  
Install a valve (3) and a dirt filter (4) at the outlet of the tank or silo containing supply water. If there are several water supply sources, then install a non-return valve in each supply line (5) so that water cannot flow from one tank or silo to another.
3. **Supply capacity**  
If the water supply capacity is too low, over time the mixing tank will become so empty that the low level protection is activated. The supply capacity must therefore be slightly higher than the capacity of the system pump that has been selected.
4. **Supply pump**  
If a pump is used to deliver supply water, then this supply pump (6) may form part of the unit and/or be controlled from the unit.
5. **Filter**  
If it is expected that solid particles > 500 µm will be carried along with the supply water then install a filter (7). Depending on the type of dirt/particles, a choice can be made between a sand filter and a screen filter (sieve filter). The position of the filter with respect to the pump depends on the type of filter. See also [Filters \(page 59\)](#).
6. **Bleed valves**  
Install bleed valves (8) at the highest point so that the supply system can be bled (in order to limit water hammer), and drain valves (9) at the lowest point so that the supply system can be fully emptied (in the event of frost).
7. **Bypass**  
Consider installing a bypass with a pump and shut-off valves (10) between the supply side of the mixing tank and the main irrigation line. This allows the crop to still be irrigated manually (where the irrigation valves have to be operated manually) in the event of a malfunction. If a supply pump has been fitted on the unit, a small adjustment of the unit is required: a T-piece must be installed on the delivery side of the supply pump.
8. **Pressure reducing valve**  
The water pressure on the filling valve must not be less than 2 bar and the supply capacity must be at least the same as the capacity of the system pump. The pressure must not, however, be higher than 4 bar either. If a higher pressure is expected (with water supply from a mountain lake that is at a greater height for example) then install a pressure reducing valve (11).
9. **Electrically operated supply valve**  
Install a fast-acting electrically operated supply valve (12) to shut off the pressurised water supply when the unit is not in operation. This valve can be controlled by the process computer (via the unit).
10. **Overflow pipe**  
If necessary, install an overflow pipe on the mixing tank and connect it to a drain (such as the sewer).
11. **EC pre-control**  
If drain water is recycled, an EC pre-control (13) can be used (if this is an option for the relevant model). This type of pre-control comprises 2 valves that are contra-controlled by a common motor. One valve allows drain water (with a high EC value) to pass and the other fresh water (with a low EC value). The further one valve closes, the further the other opens and vice versa. The EC value of the mixed water is measured by a separate EC sensor (14).  
The control software controls the motor on the valves so that the supply water has a constant, desired EC value. For effective control, the EC values of the drain water and clean water must differ by at least 0.5 mS/cm.
12. **Flow control**  
A flow control (15) can also be used (if this is an option on the model concerned) to mix different water supply sources at a specific flow rate ratio. The motor on the valves is then controlled based on flow rate measurements. The extra EC sensor (14) is not required.

## Installing the fertiliser and acid or lye supply



The starting point is that the fertiliser and acid or lye tanks are still empty. Should this not be the case, then take extreme care and observe the safety precautions as mentioned in the beginning of this manual.



For the tanks, lines and filters there is no distinction made between fertilisers and acid or lye. Where there is a distinction, this is specifically mentioned.

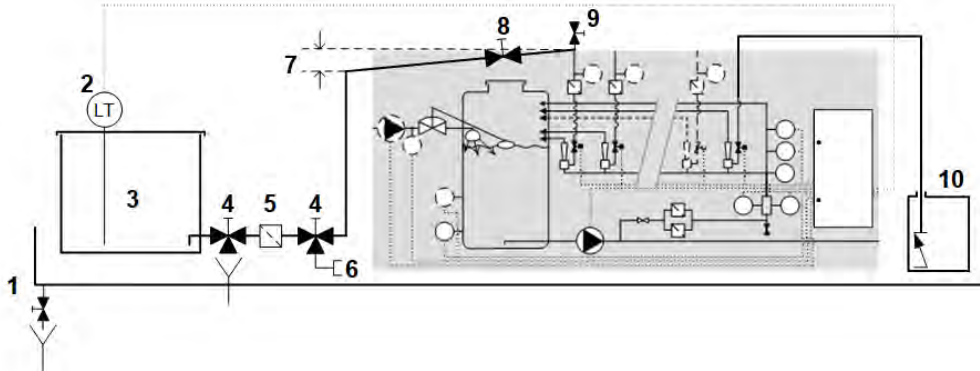

### Installing the fertiliser supply

The figure merely illustrates the possible components including a single fertiliser tank and one acid or lye tank.

## Fertiliser tanks and acid or lye tanks

Attention should be paid to the following when installing the fertiliser tanks (3) and acid or lye tanks:

### 1. Size

The fertiliser tanks must be large enough that in the summer they provide storage space for a good 24-hours and preferably for a week. Consider connecting two fertiliser tanks per fertiliser line. This allows new fertiliser to be prepared without interrupting the current program. When one fertiliser tank is almost empty the other fertiliser tank can be selected by turning manually operated valves.

### 2. Position the tanks:

- in the facility for capturing and disposing of leaking chemical substances (1);
- with the outlet at the same height as the bottom of the unit;
- with the entire bottom surface supported;
- so that they cannot easily be damaged, by mobile equipment for example;
- so that there is sufficient workspace around them;
- with a cover on the tank (the cover must not be closed airtight);
- in accordance with locally applicable regulations.

### 3. Drawing-in point

The fertilisers can best be drawn in from approximately 5 cm above the bottom of the tank. This prevents sediment from being drawn off the bottom, which would otherwise lead to blockages. Create a leak-free penetration in the tank wall for the outlet line. Install a plastic valve (4) in the outlet line.

### 4. Level sensor

If balance level control is used, fit the respective fertiliser tanks with a chemical resistant level sensor (2).

### 5. Mixer

Use chemical-resistant electric agitators in the fertiliser tanks to mix the solutions and then keep them mixed homogeneously.

For extra concentrated acid and for aqueous chemical substances that are dosed in very small quantities, Priva can supply 38% acid dosing channels and low-volume dosing channels respectively (see [Dosing channels \(page 48\)](#)). A thin hose is connected to these dosing channels. The end of the hose with foot valve is suspended directly in the barrel of acid or chemical substance (10). Position the barrel in such a way that it cannot fall over.

## Fertiliser filters

The fertiliser solution may contain solid particles such as dirt, grains of sand, incompletely dissolved fertilisers and crystallised fertilisers. Carefully filtering the fertiliser solutions is therefore crucial in preventing blockages in the dosing channels and damage to the dosage valves. Defects to the dosage valves caused by a lack of adequate filtering are not covered by the warranty.

Attention should be paid to the following when filtering the fertilisers:

1. **Passage size**  
Install a filter with a passage size of < 500 µm (5) in the fertiliser line, as close as possible to the fertiliser tank.
2. **Valves**  
Fit plastic valves (4) on either side of the filter (the valve that is already present on the outlet line of the fertiliser tank can serve as the valve on the inlet side of the dirt filter). By using three-way valves, making a hose connection on the valve on the outlet side of the dirt filter (6) and including a drain valve for the inlet side of the dirt filter (possibly a three-way valve), it is possible to connect a flushing pump and to backwash the dirt filter with water.
3. **Dosing channels**  
The dosing channels (with the exception of 38% acid and low-volume dosing channels) have built-in dirt filters. However, these do not capture the smaller particles. Therefore, install a filter with a passage size of < 130 µm at the end of each fertiliser line. If necessary, install plastic taps and a rinse water connection on both sides (similar to the arrangement around the filter at the beginning of the fertiliser line).



Do not use a filter on lines containing nitric acid at a concentration > 10 % (weight percent). The filters are not resistant to this. Ensure that no dirt gets into the nitric acid tank and that filtered nitric acid is supplied.

## Fertiliser lines and acid or lye lines

### Fertiliser lines or lines for acid to 10 % (weight percent)

For the installation of fertiliser lines and lines for diluted acid up to 10% (weight percent) or lye, the following points should be considered:

1. **Material**  
Use reinforced PVC water hoses or PVC pipes.  
Use hoses of Ø 19 x 27 mm that can be connected to the ribbed hose connector (standard Ø 20 mm) of the dosing channel. Instead of a hose connector you can also use an adaptation ring for bonding (for PVC pipe Ø 20 mm).
2. **Length**  
Keep the line between the fertiliser tank and the dosing unit as short as possible; no longer than approx. 8 m, to maintain maximum dosage capacity.
3. **Separate fertiliser lines**  
If a number of units are installed with common fertiliser tanks then install a separate fertiliser line for each unit. If there are multiple units on the same fertiliser line, dosing problems may arise as a result of water hammer on account of the pulsating opening and closing of the dosage valves.
4. **Valve**  
Install a plastic valve (8) and a hand valve (9) at the end of the lines for flushing, draining and/or bleeding.
5. **Equal resistance**  
Ensure that the lines from the fertiliser tanks have the same resistance as far as possible (same length, diameter, accessories) to ensure that equal amounts of the various fertilisers are suctioned-in.
6. **Prevent burrs**  
Do not saw-off hoses but clip or cut them off to prevent burr remnants in the dosing channels. Remove the burrs if sawing is unavoidable (with a PVC pipe, for example).
7. **Prevent corrosion**  
Secure hoses with stainless steel hose clamps (AISI 316 or material number 1.4401) that close securely all-round. Do not use ordinary iron hose clamps: they will quickly corrode through.
8. **EPDM sealing materials**  
For base or slightly acidic fertiliser solutions, use EPDM sealing materials (such as O-rings in screw couplings).

### Lines for small flow rates of fertilisers or lines for acid to 38 % (weight percent)

38% acid dosing channels and low volume dosing channels (< 50 l/h) are supplied with a 5 m PTFE hose of an inside diameter of Ø 4 mm, with a foot valve at the end that should be suspended in the acid or fertiliser tank.

### Other points of interest

1. **Ascending lines**

Install the lines in an ascending direction, towards the connection of the dosing channel (7), so that any air bubbles can easily escape through the venturi of the dosing channels and the lines remain free of air bubbles.



An air bubble in the fertiliser line works like an air spring and as a result the pulsing dosage valve suctions-in too little or no fertiliser, acid or lye.

2. **Finishing steps**

Install the lines in such a way that no-one can trip over them and they cannot be pulled out by mobile equipment.

3. **Markings**

Mark the lines to clearly indicate the chemical substances contained in the lines.

## Install the water distribution

- i** The following instructions are based on direct distribution. With indirect distribution, only one line is required which runs out into the top of the stock tank.

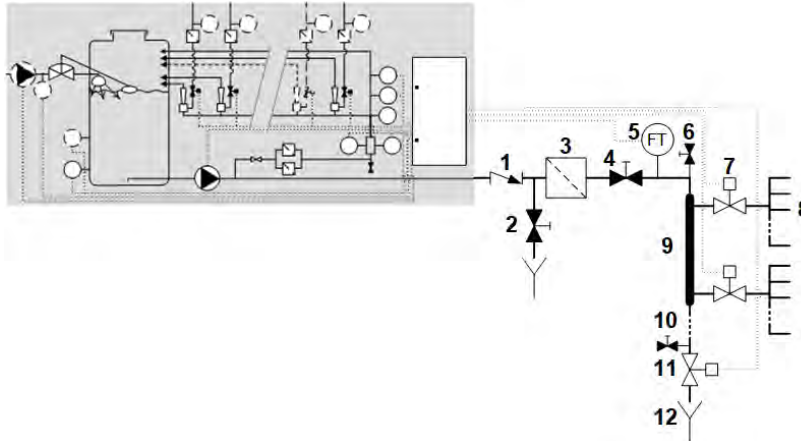

### **Install the water distribution**

The figure merely illustrates possible components. The actual components required depend on the desired configuration.

Attention should be paid to the following when installing the water distribution:

1. **Non-return valve**  
Install a non-return valve (1) between the unit and the main irrigation line to ensure that irrigation water cannot flow back to the unit in the event of a standstill. The mixing tank can overflow as a result of backflow.
2. **Discharge valve**  
Install a manually operated discharge valve (2) on the side of the unit and a manually operated valve (4) between the unit and the main irrigation line. These are required for commissioning, cleaning and emptying the system. Connect the discharge valve to the sewer or the drain water system.
3. **Filter**  
If necessary, install a filter (3) between the unit and the main irrigation line to prevent blockages in the distribution system. Depending on the type of dirt or particles, you can choose to install a sand filter or a screen filter (sieve filter).
4. **Flow sensor**  
Install a flow sensor (5) at the start of the main irrigation line. This flow sensor is necessary if the dosing system has to be able to control the amount of irrigation water. If the filter (3) is a large sand filter, it is better to install the flow sensor before the filter. In this way, the control software can ensure that after a recipe change the filter is rinsed with precisely the right amount of irrigation water.
5. **Bleed valves and drain valves**  
At the highest and lowest points, install bleed valves and drain valves respectively (6 and 10) in order to be able to bleed the distribution system, to clean it and fully empty it (e.g. in the event of frost).
6. **Irrigation valves and irrigation lines**  
Select the irrigation valves (7) and the irrigation lines so that the flow in the various valve sections (8) is as equal as possible and matches the capacity of the system pump. The irrigation valves may be connected to one long line running along all the valve sections. The irrigation valves may also be connected to a manifold (9) close to the unit with separate lines to the various valve sections.
7. **Flush valve**  
Install a flush valve (11) at the end of the main irrigation line. This is important for changing recipes and cleaning and emptying the system (for instance in the event of frost). Connect the flush valve to the sewer or drain water system (12). Use an electric flush valve if the unit can control it.

8. **Damping tank or safety valve**

Consider – especially on large distribution systems – installing a damping tank or a safety valve to limit water hammer. For the same reason, the flow rate in plastic lines may never exceed 2 m/s (nominal rate 0.5 – 1.2 m/s) and sharp bends must be avoided in the pipe-work.



## Installation - electrical part



Read the safety instructions in [Safety \(page 7\)](#) before installing the unit.



When connecting sensors use cable with a core diameter of at least 0.8 mm (cross-sectional area 0.5 mm<sup>2</sup>). For a cable length of 300 – 600 m, connect a second core in parallel with each core.

### Cabinet layout

The layout of the cabinet is largely customer-specific and is determined during the purchasing process. You can find more information on the components and connections in the project drawings and the hardware manual of the process computer.

#### Compass substation cabinet

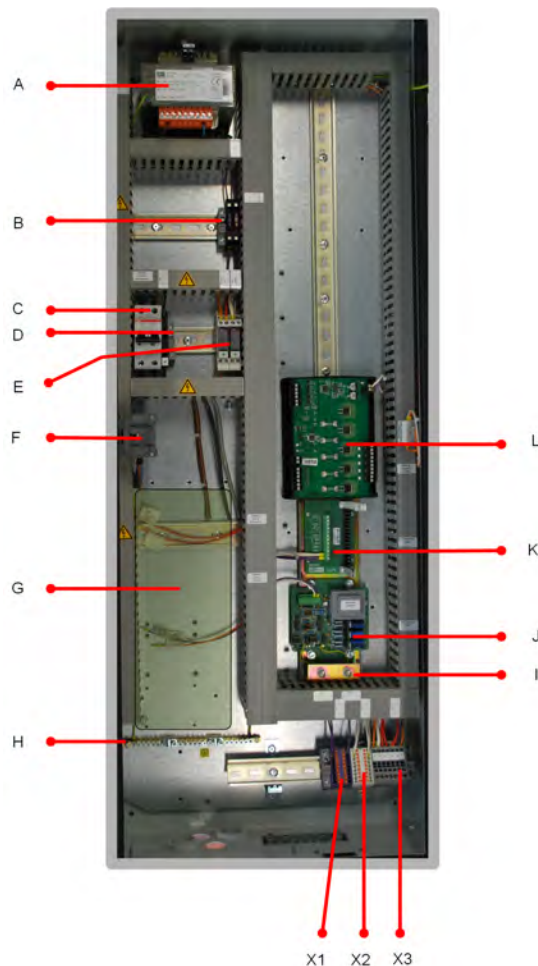

A	Power supply 24 VAC / 300 VA	I	pH sensor connection
B	fuses 24 VAC	J	pH Interface VP9969
C	circuit breaker	K	EC Interface VP8658/VP9943
D	primary fuse 24 VAC	L	Dosing Channel Driver
E	low level relay	X1	24 VAC
F	main switch	X2	0 VAC
G	pump control	X3	connections for level switch, alarm on/off and fill pump
H	earth bar		

## Cable entry

The underside of the cabinet has a cable entry and cable glands.

The cable glands are intended for various types of cabling. Always seal a cable gland with a supplied dummy plug if a cable entry is not being used.

The cable entries are intended for various types of cabling.

-  Always use a cable entry or cable gland that is suitable for a cable type with the specified cable diameter.

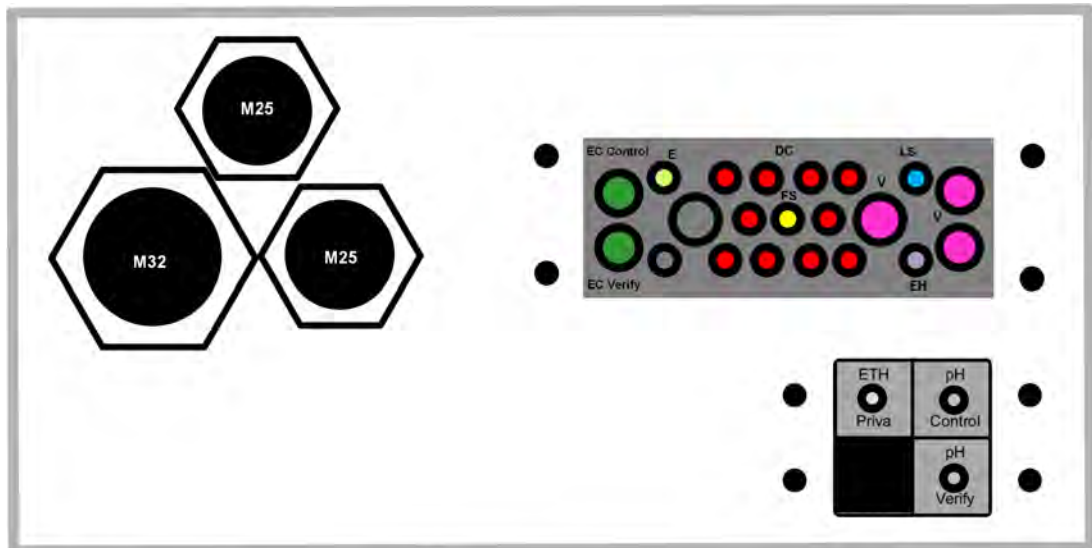

*Underside of cabinet - plan view of interior*

Cable gland/cable entry	Number	Cable type	Cable diameter
Cable gland M32	1	mains power supply	10 ... 21 mm
Cable gland M25	2	fill pump, field equipment	9 ... 16 mm
E	1	earth wire between earth bar and frame	4.0 ... 7.5 mm
EC	2	EC sensor	5.5 ... 10.5 mm
DC	10	dosage valve	4.0 ... 7.5 mm
LS	1	low level sensor	4.0 ... 7.5 mm
FS	1	flow sensor	3.2 ... 6.3 mm
EH	1	external hold	4.0 ... 7.5 mm
V	2	valve	8.0 ... 12.5 mm (1x) 4.0 ... 7.5 mm (2x)
ETH	1	network cable	5.0 ... 6.0 mm
pH	2	pH sensors	2.0 ... 3.0 mm

## Connecting the power supply



First set the correct mains voltage before connecting the power supply and switching on the unit.

### Setting the mains voltage

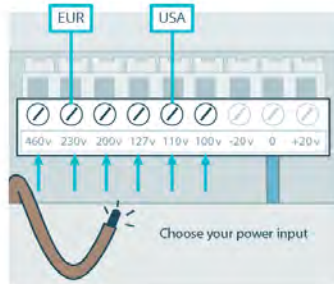

The unit is suitable for various mains voltages. The transformer converts the mains voltage to the 24 VAC system power. You must set the locally used mains voltage on the transformer. When the unit is delivered, the phase wire is connected to the 230 VAC screw clamp on the input side of the transformer. Change the voltage input as follows:

1. Turn off the main switch.
2. Switch the circuit breaker off.
3. Disconnect the phase wire from the unused screw clamp.
4. Connect the phase wire to the terminal that corresponds to the local mains voltage.  
Example: Europe has a 230 VAC network. In Europe, therefore, connect the phase wire to the 230V screw clamp.
5. Check the connections of the neutral wire and earth wire. These are already connected upon delivery.

## Connecting the power supply

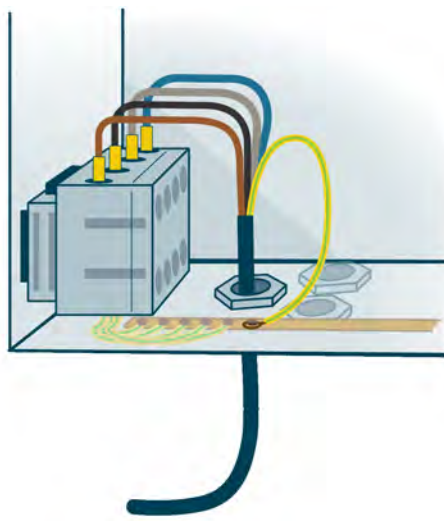

The unit is supplied without a mains cable. Select a mains cable based on the local regulations and current consumption.

A cable gland on the bottom of the cabinet is reserved for the mains cable to pass through.

## Replacing fuses



Only replace fuses with fuses of the same type (the same rating and characteristics).

See the hardware manual of the process computer of concern, for the fuses on the various PCBs.

# Parts

## Pump

### Pump control

Depending on the customer-specific configuration, the unit is equipped with a system pump control via a magnetic switch (< 4 kW) or via a softstarter (> 4 kW). The pump cable is connected directly to the magnetic switch or the softstarter.

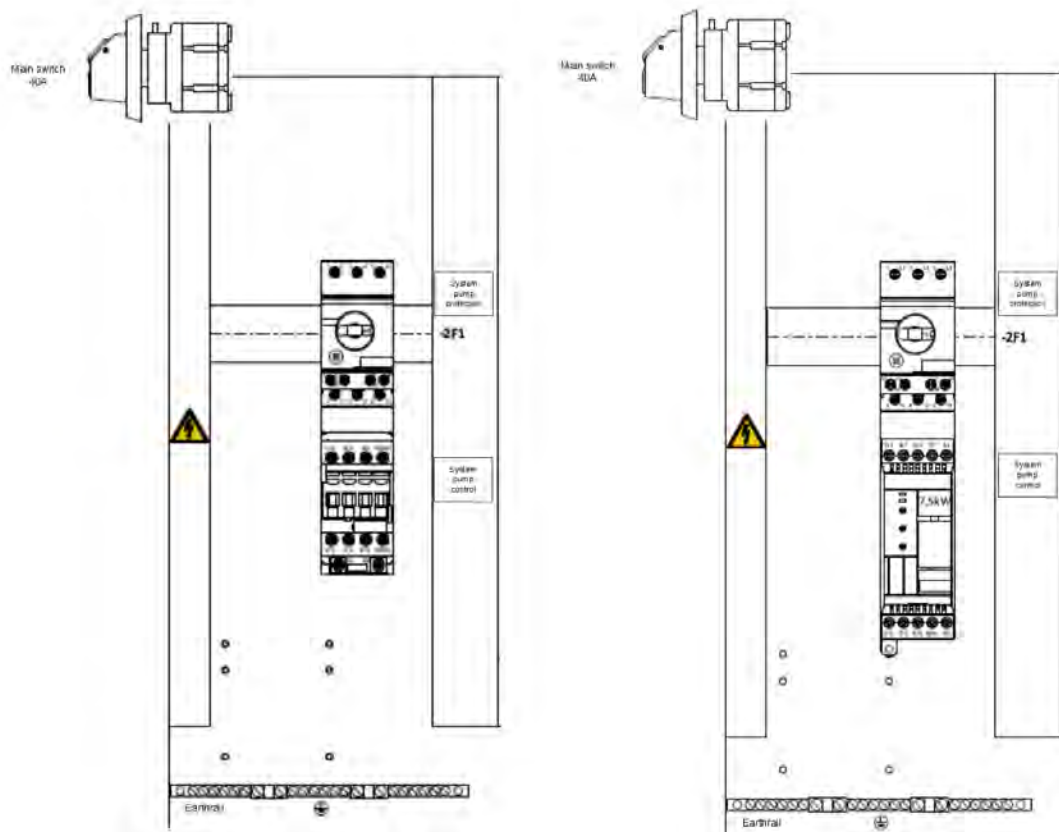

**Magnetic switch (left) and softstarter (right)**

### Technical specifications - pumps

- The mains voltage and mains frequency must be specified on ordering.
- The table presents the commonly used mains voltage (380 - 415 VAC/3 phases, neutral and earth).

Pumps for other mains voltages, with different nominal flows and other lift heights, or with an integrated pressure control, are available on request, e.g.:

- 220 – 240 VAC/50 Hz/3 phases and earth without neutral
- 208 – 230 VAC/60 Hz/3 phases and earth without neutral
- 440 – 480 VAC/60 Hz/3 phases and earth without neutral
- 346 – 380 VAC/60 Hz/3 phases and earth without neutral
- More technical specifications for the pumps can be found in the supplied pump manual.



The article numbers shown in the table below apply to a complete pump set, including control circuit (magnetic switch for pump < 4 kW and softstarter for pump > 4 kW).

### Pump specifications

Article number	Type of pump	Usage	Mains frequency and voltage	Power consumption of pump (kW)	Nominal <sup>1)</sup> flow (m <sup>3</sup> /h)	Lift height (m water column) at nominal <sup>1)</sup> flow
8871	CR15-2	supply pump	50 Hz 3x 380 – 415 VAC (3 phases, neutral and earth)	2.2	17	22
8811	CR15-3	system pump		3.0	17	33
8812	CR15-4			4.0	17	44
8873	CR20-2	supply pump		2.2	21	22
8815	CR20-3	system pump		4.0	21	35
8816	CR20-4			5.5	21	46
8876	CR32-2-2	supply pump		3.0	30	23
8821	CR32-2	system pump		4.0	30	29
8823	CR32-3-2			5.5	30	38
8822	CR32-3			5.5	30	43
8881	CR45-2-2	supply pump		5.5	45	31
8832		system pump		30		
8831	CR45-2			7.5	45	37
8886	CR64-1	supply pump		5.5	64	21
8841		system pump		20		
8843	CR64-2-1			11.0	64	36
8842	CR64-2			11.0	64	42
8872	CR15-2	supply pump		60 Hz 3 x 380 – 480 VAC (3 phases, neutral and earth)	3.0	21
8813		system pump	29			
8814	CR15-3		4.0		21	44
8874	CR20-2	supply pump	4.0		25	31
8819		system pump	31			
8818	CR20-3		5.5		25	47
8877	CR32-1	supply pump	3.0		36	21
8824	CR32-2-2	system pump	5.5		36	33
8825			7.5			42
8882	CR45-1-1	supply pump	5.5		54	22
8834	CR45-1	system pump	7.5		54	27
8833	CR45-2-2		11.0		54	43
8887	CR64-1-1	supply pump	7.5		77	21
8846		system pump	20			
8844	CR64-1		11.0		77	30

<sup>1)</sup>Nominal flow (in case of system pump) when using 3 venturis (a standard dosing channel has 1 venturi). With the CR-15, CR-20 and CR-32 pumps, this concerns the venturis of 300 l/h dosing channels with a nozzle of 2.7 mm. With the CR-45 and CR-64 pumps, this concerns 600 l/h dosing channels.

## pH interface

### Connecting the pH interface



The installation and maintenance of the pH sensor is described in detail in the pH sensor manual.

1. Connect the BNC connector of the pH sensor to the BNC connector of the pH interface.
2. Unscrew and open the pH interface.
3. Feed the cabling through the cable gland.
4. Connect the wiring of the universal input of the Priva Blue ID module and the power supply to the connector terminals of the interface. Use a 6-core shielded cable with cores of 6 x 0.8 mm (0.5 mm<sup>2</sup>).
5. Screw the interface closed.

#### Connecting the cable

Name	Function	Connection
24V	24 VAC	FP or 24 VAC from external power supply
0V	0 VAC	FG or 0 VAC from external power supply
PH1	sensor signal pH sensor 1	UI Add a pull-down resistor (100kΩ) to GND for cable break detection.
GND	pH sensor 1 GND (not electrically isolated)	FG
PH2	sensor signal pH sensor 2	UI Add a pull-down resistor (100kΩ) to GND for cable break detection.
GND	pH sensor 2 GND (not electrically isolated)	FG

### Technical specifications - pH-interface

Article description	pH-interface
Article number	3771056
Housing material	aluminium
Dimensions H x L x W (without grommet)	85 x 120 x 120 mm
Connections	on housing: <ul style="list-style-type: none"> <li>• 2 BNC-connectors for 2 pH-sensors (3770946)</li> </ul> on pH-interface board 9969: <ul style="list-style-type: none"> <li>• 24 VAC input power supply</li> <li>• 2 analog outputs</li> </ul>
Supply voltage	24 VAC
Ambient temperature	0 ... 35 °C

## pH sensor

### Fitting the pH sensor

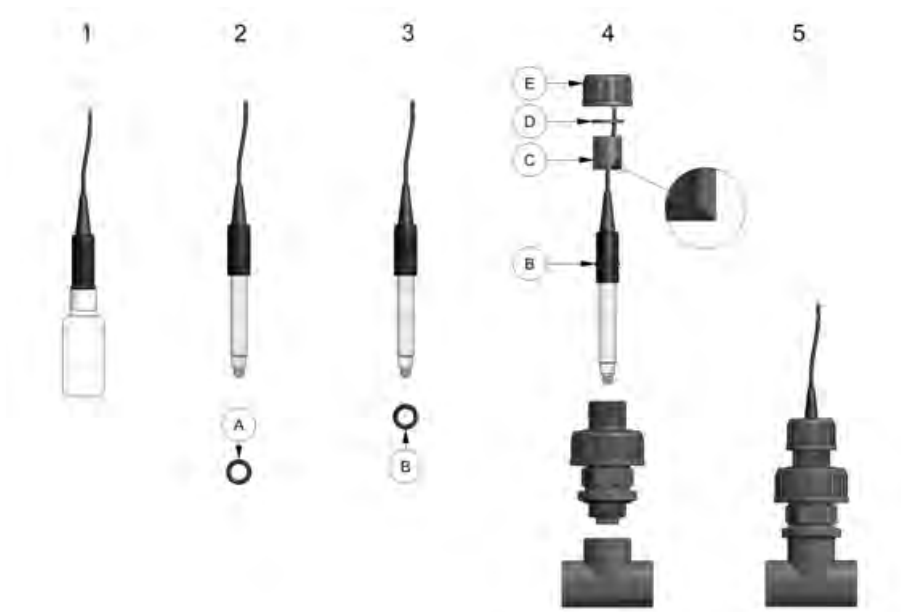

#### ***Fitting the pH sensor***



Follow the procedure below without break so that the pH sensors remain wet.

1. Remove the pH sensor from the packaging containing storage liquid.
2. Remove ring (A, if present) from the pH sensor.
3. Slide the O-ring (B) of the holder over the pH sensor.
4. Assemble parts C, D and E in the order shown in the figure. Ensure that the bevel on C is at the bottom.



Pour water into the holder if it is still dry.

5. Connect the pH sensor to the PCB for pH sensors in the cabinet.
6. Calibrate the pH measurement (refer to [Calibrating the pH measurement \(page 38\)](#)).
7. Screw the pH sensor onto the pH sensor holder.

### Calibrating the pH measurement

Calibration is described in the software manual of the relevant process computer (Connex or Compass) and depends on the software version used. See chapter *Procedures > Maintaining, checking and calibrating*.



## Cleaning the pH sensors



### ***pH sensor holder and pH sensor***

The pH sensors have to be unscrewed from the pH sensor holder for cleaning. Only do this when the unit is in maintenance mode (software-wise and pump switch(es) off). Check the screw coupling on the pH sensor holder for leaks after putting back into operation.

-  In principle, the sensor cables in the cabinet can remain connected during maintenance. However, the sensor cables must be disconnected if the current situation requires this so that cleaning can take place elsewhere.

### **Cleaning the pH sensor normally**

1. Clean the glass membrane and the housing of the sensor with a solution of liquid detergent in warm water. Use a soft brush or a clean cloth, dipped in the soap solution. Do not use a paper towel.

-  Do not apply excessive pressure to the glass membrane as it is fragile.

2. Rinse the glass membrane well with distilled water. Then immerse the sensor for at least 30 minutes in a 50/50 mixture of pH 4 buffer and 4M KCl before using it again.

-  It is advisable to recalibrate the pH measurement after cleaning.

### **Cleaning the pH sensor thoroughly**



If there is an anorganic deposit on the pH sensor then remove it as follows:

1. Make a homogeneous acid dilution of:
  - approximately 1 part drinking water and 1 part concentrated nitric acid (38% (by weight))
  - or
  - 4 parts drinking water and 1 part concentrated phosphoric acid (59% (by weight)).

-  Add the acid to the water; never add water to acid.

2. Immerse the glass membrane of the pH sensor in the acid solution for 5 minutes (no longer!).
3. Rinse the pH sensor with drinking water, and rinse the glass membrane with distilled water. Next, calibrate the pH measurement.

- 
4. Dispose of the acid dilution in accordance with the locally applicable regulations.

### Technical specifications - pH sensor

Article description	pH sensor (max. 10.0 bar)
Article number	3779046
Housing	glass
Length of sensor	77 mm
Diameter of sensor	Ø 12 mm (Ø 15 mm with protective cover)
Measurement principle	pH electrode for H <sup>+</sup> ions
Discrimination	59 mV/pH (in operating range 4 .. 7 pH at 25 °C)
Operating range (measured values satisfy the specified accuracy)	4 .. 7 pH
Range (sensor produces measured values)	3 .. 14 pH
Accuracy (after calibration)	± 0.1 pH (in operating range 4 .. 7 pH at 5 .. 30 °C)
Cable	coax, Ø 2.5 mm, length 3 m
Connector	BNC

## EC-DSS interface

### Operation of EC-DSS interface

The EC-DSS interface allows you to connect EC sensors or drain sensor systems (DSS). You can connect two EC sensors or drain sensor systems to one EC-DSS interface. The EC-DSS interface can be expanded with a second EC interface board 8658 and connection board 9943 to enable you to connect two more EC sensors or drain sensor systems.



### Connecting the EC-DSS interface

1. Unscrew and open the interface.
2. Feed the cabling through the cable glands.
3. Connect the wiring of the EC sensor or DSS to the connector terminals of the interface. Use a 4-core shielded cable with cores of 0.34 mm<sup>2</sup> (diam. 0.64 mm).
4. Connect the wiring of a second EC sensor or DSS to the connector terminals of the interface. Use a 4-core shielded cable with cores of 0.34 mm<sup>2</sup> (diam. 0.64 mm).
5. Connect the wiring of a universal input of the Priva Blue ID module to the connector terminals of the interface. Use a 4-core shielded cable with cores of 0.8 mm (0.5 mm<sup>2</sup>).
6. Connect the wiring of the power supply to the connector terminals of the interface. Use a 2-core shielded cable with cores of 0.8 mm (0.5 mm<sup>2</sup>).
7. Screw the interface closed.

### EC cable to EC-DSS interface

EC cable	EC-DSS interface	
Core colour	Measuring cell 1	Measuring cell 2
White	6 (EC)	3 (EC)
Yellow	5 (Common)	2 (Common)
Grey	Do not connect	Do not connect
Green	4 (Temperature)	1 (Temperature)
Brown	5 (Common)	2 (Common)

**EC-DSS interface cable to Compass**

Name	Function	Connection
MB1	sensor signal sensor 1	UI of Priva Blue ID module Add a pull-down resistor (100kΩ) to GND for cable break detection.
GND	GND	FG of Priva Blue ID module
MB2	sensor signal sensor 2	UI of Priva Blue ID module Add a pull-down resistor (100kΩ) to GND for cable break detection.
GND	GND	FG of Priva Blue ID module
0 VAC	0 V	0 VAC of power supply
24 VAC	24 V	24 VAC of power supply

**Expanding the EC-DSS interface**

1. Unscrew and open the interface.
2. Screw a connection board 9943 to the bottom plate.
3. Insert an EC interface board 8658 into the connector of the connection board 9943.
4. Screw the interface closed.

**Technical specifications - EC-DSS-interface**

Article description	EC-DSS-interface
Article number	3771051
Housing material	plastic
Dimensions H x L x W (without grommet)	180 x 165 x 135 mm
Connections	on EC-interface board 8658: <ul style="list-style-type: none"> <li>• 24 VAC input power supply</li> <li>• 2 inputs for EC or DSS</li> <li>• 2 analog outputs</li> </ul>
Supply voltage	24 VAC
Ambient temperature	0 ... 35 °C

## Connecting the Compass EC sensor

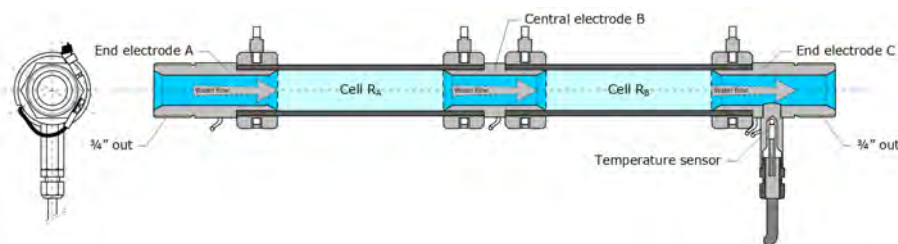

**Cross section of inline EC sensor**

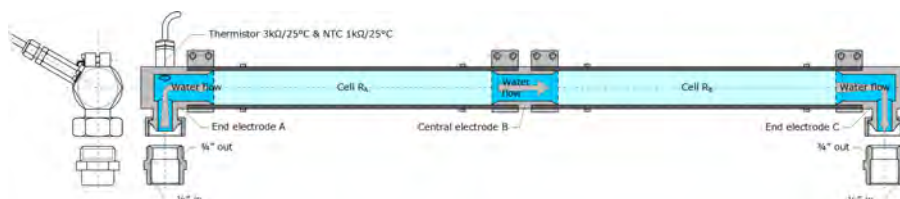

**Cross section of angled EC sensor**

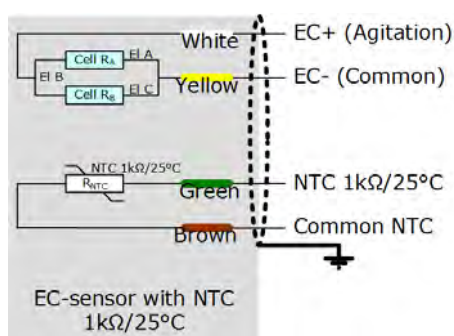

**Connecting the Compass EC sensor**

EC sensor	EC interface VP9943+VP8658	
Core colour	Measuring cell 1	Measuring cell 2
White	6 (EC)	3 (EC)
Yellow	5 (Comm.)	2 (Comm.)
Grey	Do not connect	Do not connect
Green	4 (Temp.)	1 (Temp.)
Brown	5 (Comm.)	2 (Comm.)

1. Connect the EC sensor to the interface with a 4-core shielded cable with cores of 0.34 mm<sup>2</sup> (Ø 0.64 mm).
2. It may be possible to extend the cable. Extending the cable will, however, increase the measuring error (see tables below).



In the case of an EC measurement via single cores, limit the length to 60 m.

3. Connect the shielding on the cable to the earth bar in the housing.
4. Adjust the cell factor with the potentiometer, see [Calibrating the EC measurement \(Compass\)](#) (page 44).

Cable length (2x 0.34 mm <sup>2</sup> )	Measuring error at 15 mS	Measuring error at 10 mS	Measuring error at 5 mS	Measuring error at 0.1 mS
5 m	1%	0.5%	0.3%	--
60 m	9%	6%	3%	0.1%
120 m	16%	11%	6%	0.1%

Cable length (4x 0.34 mm <sup>2</sup> )	Measuring error at 15 mS	Measuring error at 10 mS	Measuring error at 5 mS	Measuring error at 0.1 mS
5 m	0.4%	0.3%	0.1%	--
60 m	5%	3%	1.5%	--
120 m	9%	6%	3%	0.1%

## Specifications for EC sensor

Article description	Inline EC sensor, short, with NTC 1 k $\Omega$ /25 $^{\circ}$ C	Inline EC sensor with NTC and thermistor	Angled EC sensor, long, with NTC 1 k $\Omega$ /25 $^{\circ}$ C	Angled EC sensor with NTC and thermistor
Article number	3779052	3779043 This part is no longer available.	3779041	3779045 This part is no longer available.
Temperature sensors	NTC 1 k $\Omega$ /25 $^{\circ}$ C	NTC 1 k $\Omega$ /25 $^{\circ}$ C Thermistor 3 k $\Omega$ /25 $^{\circ}$ C	NTC 1 k $\Omega$ /25 $^{\circ}$ C	NTC 1 k $\Omega$ /25 $^{\circ}$ C Thermistor 3 k $\Omega$ /25 $^{\circ}$ C
Spare parts	NTC 1k with cable, short EC sensor (3476073)	-	NTC 1k with cable, long EC sensor (3476074)	-
Measurement range	0.01 to 15 mS/cm		0.01 to 15 mS/cm	
Cell factor	1.23 cm/cm <sup>2</sup>		1.82 cm/cm <sup>2</sup>	
Temperature compensation	Necessary approx. 1.8 to 2.2 %/ $^{\circ}$ C		Necessary approx. 1.8 to 2.2 %/ $^{\circ}$ C	
Temperature range	0 to 45 $^{\circ}$ C (when active) 0 to 65 $^{\circ}$ C (when inactive)		0 to 45 $^{\circ}$ C (when active) 0 to 65 $^{\circ}$ C (when inactive)	
Pressure range	Maximum 10 bar		Maximum 6 bar	
Flow speed	0.5 to 25 m <sup>3</sup> /hour		0.5 to 25 m <sup>3</sup> /hour	

## EC sensor

### Calibrating the EC measurement (Compass)

Have the EC sensor calibrated by a dealer at least once a year. The calibration can be done using a portable EC meter. Use the portable EC meter to determine the EC value of the water within the sensor.



A portable reference EC meter is required for calibrating the EC measurement, like Portable EC and pH analyzer (3779190) or Portable EC analyzer (3779191).

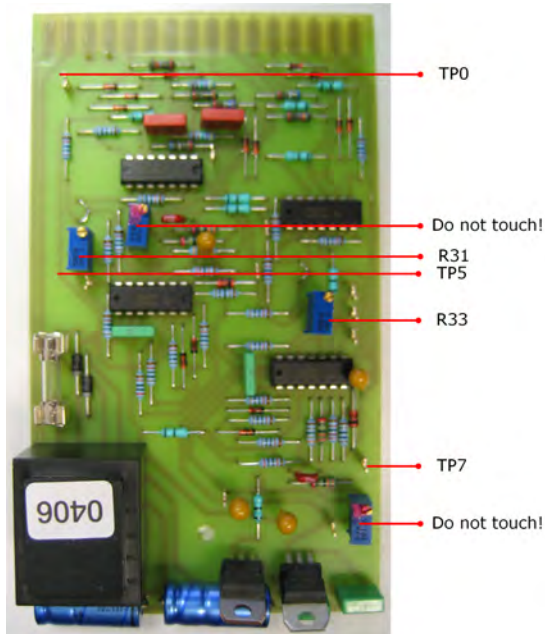

### EC Interface VP8658

1. Go to *Water Room > Water system > Settings > Stop water system for maintenance* and select *IMMEDIATE*.
2. Make sure that water with a constant composition is pumped through the EC measuring sensor. Use the available valves and pumps of the unit, depending on the type of unit and the model.
  - 💡 For a usable calibration the EC value must be within the unit's normal control range, for instance around 2 mS.
3. Collect some water with fertiliser and measure its EC value using a reference EC meter.
4. Calculate the desired output signal (in mV) of the EC Interface VP8658:  $\text{desired output signal} = \text{EC value} \times 500$ .
5. Connect a digital multimeter to test point TP0 (Gnd) and TP5 (signal EC sensor 1) on EC Interface VP86583.
6. Adjust the potentiometer R13 until the multimeter shows the desired output signal (calculated in step 4).
7. Connect a digital multimeter to test point TP0 (Gnd) and TP7 (signal EC sensor 2) on EC Interface VP86583.
8. Adjust the potentiometer R33 until the multimeter shows the desired output signal (calculated in step 4).
9. Go to *Water Room > Water system > Settings > Stop water system for maintenance* and select *NO STOP*.
10. Reset the unit valves and pumps to the correct position.

## Cleaning the EC sensors

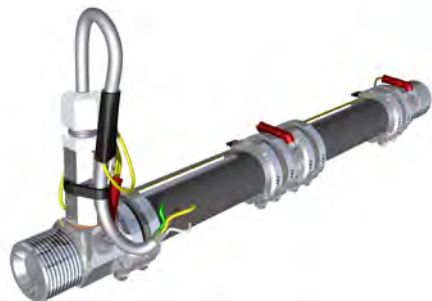

### **EC measuring tube with EC sensor**

**i** In principle, the sensor cables in the cabinet must remain connected. Maintenance work on the EC sensors must, therefore, be carried out in the immediate vicinity of the unit. For this procedure, the EC sensors must be sealed on one side. Two end caps are required for this. If you only have one, you must clean the EC sensors one by one.

1. Set the unit to maintenance mode (software-wise and pump switch(es) off).
2. Unscrew the screw couplings from the EC measuring tubes and remove the 2 EC measuring tubes from the unit.
3. Seal the EC sensors on one side with the attachment, place the EC sensors upright.
4. Fill the EC measuring tubes with strong scale remover and allow it to work in for a few minutes until no, or very few, gas bubbles are visible.

**💡** In addition to the commercially-available scale removers, you can also use nitric acid in a 3% concentration (weight percent).

5. Pour the scale remover out of the EC measuring tubes and dispose of it in accordance with the locally applicable regulations.
6. Check that the contamination has been completely removed. If not, repeat steps 3 to 6.
7. Rinse the EC measuring tubes with drinking water.
8. Replace the EC measuring tubes on the unit and tighten the screw couplings.
9. Calibrate the EC measurement (see the instructions for calibrating the EC measurement).
10. Check the screw couplings for leaks.
11. Put the unit back into operation.

## Technical specifications - EC sensor

Article description	1 EC sensor (article number 3779043) with fixing materials (single measurement)	2 EC sensors (article number 3779043) with fixing materials (dual measurement)
Article number	8408	8409
Housing material	PVC and SST	
Measurement principle	electrical conductivity with temperature compensation	
Measurement range	0 .. 10 mS/cm	
Accuracy (if properly maintained)	2 % (of max. measured value)	
Temperature compensation	1.8 .. 2.2 %/°C	
Cell constant	1.23 cm/cm <sup>2</sup>	

The EC sensor with article number 3779043 can also be used for an EC pre-control. See price list for more information on the components of the EC pre-control.



## Mixing tank low level switch

### Checking the low level switch on the mixing tank

A low level switch has been fitted at the bottom of the mixing tank to avoid the system pump running dry.

Check the operation of the low level switch as follows:

1. Ensure that the water level in the mixing tank is clearly above the low level switch.
2. Open the discharge valve and allow the unit to discharge the irrigation water.
3. Open the lid of the mixing tank and lift the control float until the filling valve remains closed. Or close the supply of supply water.
4. Check that the system pump stops before it suctions air. If it does not, then switch off the system pump immediately using the pump switch (the system pump will have to be bled again once the defect has been resolved!).
5. Close the discharge valve.
6. Resume the supply of supply water.

## Control float

### Adjusting the float control valve

**i** The filling valve must be properly bled to ensure its correct operation. In principle this occurs naturally.

Adjust the control float in the mixing tank so that the level in the mixing tank matches the bottom of the spray head when the unit is working at nominal capacity:

1. The control float arm is fitted on the pivoting point with a bolt and a self securing nut against a small lever that controls the valve. Unscrew the nut.
2. Push the lever against the valve so that the valve closes. Hold the lever in this position.
3. Position the control float arm so that the middle of the control float ball matches the desired water level.
4. Tighten the nut.

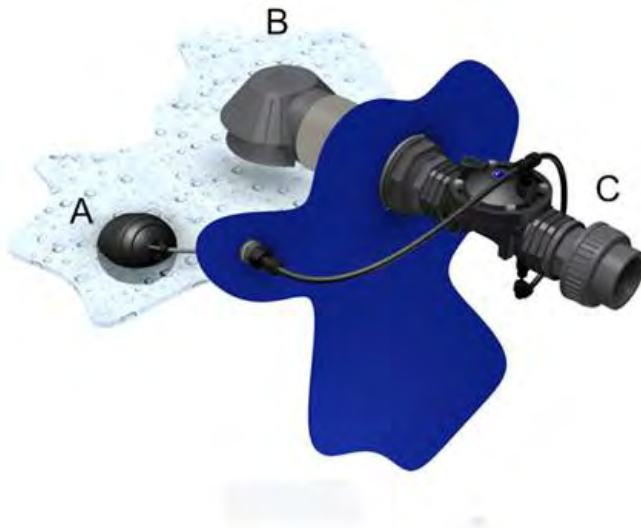

#### **Float control valve and filling valve**

- A. float control valve
- B. spray head
- C. filling valve

## Dosing channels

### Types of dosing channels

The NutriFlex has 10 dosing channel positions. If single dosing channels have been installed on all these positions, a maximum of 10 fertiliser solutions or 9 fertiliser solutions and 1 acid or lye solution can be dosed at one time.

Dosing channels are available in a range of versions:

- 300 l/h and 600 l/h dosing channels;
- 300 l/h and 600 l/h double dosing channels;
- 10% acid dosing channel;
- 38% acid dosing channel;
- low-volume dosing channels.

The mounting direction of the venturi depends on the system in which the dosing channel is being used. With dosing channels for use in an atmospheric system with a mixing tank, such as the NutriFlex, the venturi is mounted facing upwards and the PVC hose runs from the venturi to the mixing tank on the top of the dosing channel.

Refer to document *Application dosing channels* for more information.

## Technical specifications - dosing channels



The pictures of dosing channels show examples of both possible mounting directions for the venturi: upwards or downwards. The article number of the dosing channel may be the same, irrespective of the mounting direction of the venturi.

### Dosing channel 3% acid, 100 l/h

Article number	730300	
Liquids to be used	fertilisers, lye and acid solutions containing up to a 3% weight percent nitric acid	
Passage size of filter	<2 mm	
Reading range of rotameter	0 - 110 l/h	
Dosage capacity	10 - 100 l/h	
Drive water flow rate	approx. 560 l/h at 3.5 bar (Ø2.7 mm nozzle)	
Dosage valve	Buschjost, 24 VAC, 0.5 A, 50 - 60 Hz, 13 VA, PTFE membrane, PVDF housing	
Dosage valve signalling	LED (yellow)	
Flow controller	needle valve	
Non-return valve	integrated in PVC part between rotameter and valve	
Connection of fertiliser supply	hose connector Ø20 mm	

### Dosing channel 3% acid, 300 l/h

Article number	730310 (50 Hz) 730311 (60 Hz)	
Liquids to be used	fertilisers, lye and acid solutions containing up to a 3% weight percent nitric acid	
Passage size of filter	<2 mm	
Reading range of rotameter	0 - 300 l/h	
Dosage capacity	30 - 300 l/h	
Drive water flow rate	approx. 560 l/h at 3.5 bar (Ø2.7 mm nozzle)	
Dosage valve	Geva, 24 VAC, 0.60 A, 50 or 60 Hz, 8 W, EPDM membrane and restricting screw	
Dosage valve signalling	LED (red)	
Flow controller	restricting screw in dosage valve	
Non-return valve	integrated in dosage valve	
Connection of fertiliser supply	hose connector Ø20 mm	

**Dosing channel 3% acid, 600 l/h**

Article number	730320 (50 Hz) 730321 (60 Hz)	
Liquids to be used	fertilisers, lye and acid solutions containing up to a 3% weight percent nitric acid	
Passage size of filter	<2 mm	
Reading range of rotameter	0 - 1000 l/h	
Dosage capacity	60 - 600 l/h	
Drive water flow rate	approx. 1250 l/h at 3.5 bar (Ø4.0 mm nozzle)	
Dosage valve	Geva, 24 VAC, 0.60 A, 50 or 60 Hz, 8 W, EPDM membrane and restricting screw	
Dosage valve signalling	LED (red)	
Flow controller	restricting screw in dosage valve	
Non-return valve	integrated in dosage valve	
Connection of fertiliser supply	hose connector Ø20 mm	

**Dosing channel 10% acid, 100 l/h**

Article number	730332	
Liquids to be used	fertilisers, lye and acid solutions containing up to a 10% weight percent nitric acid	
Passage size of filter	< 2 mm	
Reading range of rotameter	not present	
Dosage capacity	8 .. 100 l/h	
Drive water flow rate	approx 560 l/h at 3.5 bar (Ø 2.7 mm nozzle)	
Dosage valve	Buschjost, 24 Vac, 0.5 A, 50 - 60 Hz, 13 VA, PTFE membrane, PVDF housing	
Dosage valve signalling	LED (yellow)	
Flow controller	Needle valve	
Non-return valve	in suction pipe	
Connection of fertiliser supply	Hose connector Ø 20 mm	

**Dosing channel 10% acid, 300 l/h**

Article number	730330 (50 Hz) 730331 (60 Hz)	
Liquids to be used	fertilisers, lye and acid solutions containing up to a 10% weight percent nitric acid	
Passage size of filter	<2 mm	
Reading range of rotameter	not present	
Dosage capacity	30 - 300 l/h	
Drive water flow rate	approx. 560 l/h at 3.5 bar (Ø2.7 mm nozzle)	
Dosage valve	Geva, 24 VAC, 0.60 A, 50 or 60 Hz, 8 W, EPDM membrane and restricting screw	
Dosage valve signalling	LED (red)	
Flow controller	restricting screw in dosage valve	
Non-return valve	integrated in dosage valve	
Connection of fertiliser supply	hose connector Ø20 mm	

**Dosing channel 38% acid, 50 l/h**

Article number	730341
Liquids to be used	acid solutions containing up to 38% weight percent nitric acid
Passage size of filter	not present
Reading range of rotameter	not present
Dosage capacity	5 - 50 l/h
Drive water flow rate	approx. 560 l/h at 3.5 bar (Ø2.7 mm nozzle)
Dosage valve	Buschjost, 24 VAC, 0.5 A, 50 - 60 Hz, 13 VA, PTFE membrane, PVDF housing
Dosage valve signalling	LED (yellow)
Flow controller	Needle valve
Non-return valve	integrated in PVC part between rotameter and valve
Connection of fertiliser supply	hose connector Ø 6 mm for PTFE/PVC hose (5 m long, Ø 6 mm outside diameter, Ø 4 mm inside diameter, with foot valve and level switch for pre-alarm and level switch for empty alarm).

**Dosing channel 50% lye, 50 l/h**

Article number	730345
Liquids to be used	lye solutions with max. 50% weight percent potassium hydroxide
Passage size of filter	not present
Reading range of rotameter	not present
Dosage capacity	5 - 50 l/h
Drive water flow rate	approx. 560 l/h at 3.5 bar (Ø 2.7 mm nozzle)
Dosage valve	Buschjost, 24 VAC, 0.5 A, 50 - 60 Hz, 13 VA, EPDM membrane, PVDF housing
Dosage valve signalling	LED (yellow)
Flow controller	Needle valve
Non-return valve	integrated in PVC part between rotameter and valve
Connection of fertiliser supply	hose connector Ø 6 mm for PTFE/PVC hose (5 m long, Ø 6 mm outside diameter, Ø 4 mm inside diameter, with foot valve and level switch for pre-alarm and level switch for empty alarm)

**Dosing channel 3% acid, 100 l/h**

Article number	730302
Liquids to be used	fertilisers, lye and acid solutions containing up to 3% (weight percent) nitric acid
Passage size of filter	<2 mm
Reading range of rotameter	if installed: 0 - 110 l/h
Dosage capacity	10 - 100 l/h
Drive water flow rate	approx. 560 l/h at 3.5 bar (Ø 2.7 mm nozzle)
Dosage valve	Buschjost, 24 VAC, 0.5 A, 50 - 60 Hz, 13 VA, PTFE membrane, PVDF housing
Dosage valve signalling	LED (yellow)
Flow controller	needle valve
Non-return valve	integrated in PVC part between rotameter and valve
Connection of fertiliser supply	hose connector Ø20 mm



**Dosing channel 3% acid, 300 l/h**

Article number	730312 (50 Hz) 730313 (60 Hz)	
Liquids to be used	fertilisers, lye and acid solutions containing up to 3 % (weight percent) nitric acid	
Passage size of filter	<2 mm	
Reading range of rotameter	if installed: 0 - 300 l/h	
Dosage capacity	30 - 300 l/h	
Drive water flow rate	approx. 560 l/h at 3.5 bar (Ø2.7 mm nozzle)	
Dosage valve	Geva, 24 VAC, 0.60 A, 50 or 60 Hz, 8 W, EPDM membrane and restricting screw	
Dosage valve signalling	LED (red)	
Flow controller	restricting screw in dosage valve	
Non-return valve	integrated in dosage valve	
Connection of fertiliser supply	hose connector Ø20 mm	

**Dosing channel 3% acid, 600 l/h**

Article number	730322 (50 Hz) 730323 (60 Hz)	
Liquids to be used	fertilisers, lye and acid solutions containing up to 3 % (weight percent) nitric acid	
Passage size of filter	<2 mm	
Reading range of rotameter	if installed: 0 - 1000 l/h	
Dosage capacity	60 - 600 l/h	
Drive water flow rate	approx. 1250 l/h at 3.5 bar (Ø4.0 mm nozzle)	
Dosage valve	Geva, 24 VAC, 0.60 A, 50 or 60 Hz, 8 W, EPDM membrane and restricting screw	
Dosage valve signalling	LED (red)	
Flow controller	restricting screw in dosage valve	
Non-return valve	integrated in dosage valve	
Connection of fertiliser supply	hose connector Ø20 mm	

**Dosing channel low volume**

Article number	730351 (2 l/h) 730353 (8 l/h)	
Liquids to be used	fertilisers, lye and acid solutions containing up to a 38% weight percent nitric acid hydrogen peroxide (max. 35% weight percent) hypochlorite solutions (max. 15% weight percent)	
Passage size of filter	not present	
Reading range of rotameter	not present	
Dosage capacity	0.2 - 1.8 l/h 0.8 - 7.2 l/h	
Drive water flow rate	approx. 1250 l/h at 3.5 bar (Ø4.0 mm nozzle)	
Dosage valve	Buschjost, 24 VAC, 0.5 A, 50 - 60 Hz, 13 VA, PTFE membrane, PVDF housing	
Dosage valve signalling	LED (yellow)	
Flow controller	not present	
Non-return valve	not present	
Connection of fertiliser supply	hose connector Ø 6 mm for PTFE/PVC hose (5 m long, Ø 6 mm outside diameter, Ø 4 mm inside diameter, with foot valve and level switch).	

## Inline dirt filter

### Cleaning the inline dirt filter



**Inline dirt filter**



If a manometer is installed in the distribution line, you can compare the pressure in the distribution line with the pressure in the line to the venturi's. A significant pressure difference indicates contamination of the dirt filter.

1. Set the unit to maintenance mode (software-wise and pump switch(es) to 0 (off).
2. Loosen the coupling and remove the filter element from the housing.
3. Rinse the filter element underneath the tap until clean.
4. Replace the filter element and tighten the filter element.
5. Put the unit back into operation.

### Technical specifications - inline dirt filter

Article description	Inline dirt filter and corresponding PVC coupling 32 mm
Article number	630505
Housing	PVC
Interior	PE
Mesh opening	1.4 mm

## Filter and rotameter dosing channel

### Cleaning the dosing channel filter



#### ***Dirt filter of dosing channel***

1. Set the unit to maintenance mode (software-wise and pump switch(es) off).
2. Close the valve on the fertiliser line concerned. If there are valves at the start and end of the fertiliser line then close the valve at the end (closest to the unit).
3. Place a plastic receptacle underneath the filter.
4. Unscrew the cap from the filter and remove the filter element from the filter housing.
5. Rinse the filter element underneath the tap until clean.
6. Replace the filter element and screw the cap back onto the filter.
7. Open the valve on the fertiliser line concerned.
8. Check that the filter is not leaking.
9. Empty the receptacle into the appropriate tank of fertiliser.
10. Put the unit back into operation.



## Cleaning the dosing channel rotameter



1. Set the unit to maintenance mode (software-wise and pump switch(es) off).
2. Close the valve on the fertiliser line concerned. If there are valves at the start and end of the fertiliser line then close the valve at the end (closest to the unit).
3. Unscrew the screw couplings on the rotameter and remove the rotameter.
  - ! The fertiliser that flows out cannot be collected. Therefore flush the fertiliser out of the unit using water.
4. Clean the interior of the rotameter with warm water and a small pipe brush.
5. Replace the rotameter and tighten the screw couplings.
6. Open the valve on the fertiliser line concerned.
7. Check the screw couplings for leaks.
8. Put the unit back into operation.

## Fertiliser suction

### Checking the fertiliser suction

In order to provide good fertiliser suction it is important that the venturis create sufficient vacuum and the fertiliser line and the venturi/dosing valve combination are free from air, deposits and leaks. The suction of a dosing channel can be checked in various ways, depending on the configuration:

- If the dosing channel is fitted with a rotameter, you can read off the flow based on the height of the float in the rotameter. If necessary, a rotameter can be fitted in the fertiliser line temporarily.
- If the fertiliser lines are transparent, the movement of small air bubbles and particles (of which there should be as few as possible) shows that fertiliser is being drawn to the dosing channel.
- You can measure the vacuum by temporarily replacing a dosing valve with a vacuum gauge.

## Dosage valves

### Adjusting the dosing valve

The dosing valves are controlled with pulse width modulation. The duty cycle (i.e. the ratio between the time that the valve is open and the time that the valve is closed) determines the average flow. The maximum flow is the flow when the valve is open continuously. This maximum flow is adjusted with a restriction screw on the dosing valve; see also the test report that accompanied the unit. For use of the A+B principle, the maximum flow for all dosing valves is set at the same level.



#### ***Dosing valve restricting screw***



38 % acid dosing channels and low volume dosing channels are not fitted with a restricting screw and, therefore, they cannot be adjusted. But, because of the way these dosing channels are used they do not need to be adjustable.

## Flow sensor



### Connecting

Colour	Function	Connection
Red	open collector signal output	X7-2
Black	power supply 3.3 - 24 VDC	X7-3
Metallic	ground	X7-4

### Cleaning the flow sensor

1. Set the unit to maintenance mode (software-wise and pump switch(es) off).
2. Make sure the main irrigation line is pressure-less and, if necessary, empty.
3. Unscrew the flow sensor from the T-piece.
4. Clean the paddle wheel of the flow sensor using a small, soft brush.
5. Apply a little acid-free grease to the rubber O-rings to prevent them from being damaged when placing the sensor back.
6. Screw the flow sensor back onto the T-piece: you can only do this one way.
7. Fill and bleed the main irrigation line to prevent water hammer.
8. Check that the flow sensor coupling is not leaking.

### Technical specifications – flow sensor

Article description	Flow sensor GF2536-P0 (for lines Ø 20 – 110 mm and 2 – 4")	Flow sensor GF2536-P0 (for lines Ø 20 – 110 mm and 2 – 4")	Flow sensor GF2536-P1 (for lines Ø 125 – 160 mm and 6")
Article number	750470	750470 (short housing)	750465 (long housing)
Measurement principle	paddle wheel		
Measurement range	0.3 - 3 m/s		
Accuracy	1 % (of max. measured value)		
Reproducibility	0.5 % (of max. measured value)		
IP code	IP67		
Minimum Reynolds number required	4500		
Supply voltage	3.3 - 24 VDC		
Output signal	49 Hz per m/s		
Maximum current requirement	10 mA		
Cable length	7.5 m		
Cable type	2-core shielded twisted pair (22 AWG, 0.326 mm <sup>2</sup> )		

### Technical specifications - T-piece for flow sensor

The K-factor is dependent on the flow sensor, the line diameter of the T-piece and the insertion depth. A certificate showing the K-factor is supplied with the flow sensor. If the certificate is missing, you can look up the K-factor in the tables below.



The maximum speed at which the pulses can be processed depends on the hardware used.

### T-pieces - lines with a metric diameter

Article description	PVC T-piece for flow sensor GF2536-P0, metric					
Article number	750471	750472	750473	750474	750475	750476
Line diameter, external (mm)	20 (DN15)	25 (DN20)	32 (DN25)	40 (DN32)	50 (DN40)	63 (DN50)
Measuring range (m <sup>3</sup> /hr) at a flow rate of 0.3 .. 3 m/s and lines of pressure class PN16	0.24 .. 2.4	0.38 .. 3.8	0.63 .. 6.3	0.98 .. 9.8	1.54 .. 15.4	2.44 .. 24.4
K-factor (pulses per litre)	256.9	128.32	78.54	44.98	27.4	15.72
Litre per pulse (1/K)	0.00389	0.00779	0.0127	0.0222	0.0364	0.0636

### T-pieces saddle fitting - lines with a metric diameter

Article description	Saddle fitting for flow sensor GF2536-P0, metric		
Article number	750477	750478	750479
Line diameter, external (mm)	75 (DN65)	90 (DN80)	110 (DN100)
Measuring range (m <sup>3</sup> /hr) at a flow rate of 0.3 .. 3 m/s and lines of pressure class PN16	3.46 .. 34.6	4.90 .. 49.0	7.34 .. 73.4
K-factor (pulses per litre)	9.787	7.281	4.806
Litre per pulse (1/K)	0.102	0.137	0.208

Article description	Saddle fitting for flow sensor GF2536-P1, metric			
Article number	750482	750483	750466	750467
Line diameter, external (mm)	125 (DN115)	140 (DN125)	160 (DN150)	225 (DN200)
Measuring range (m <sup>3</sup> /hr) at a flow rate of 0.3 .. 3 m/s and lines of pressure class PN16	11.3 .. 113	14.6 .. 146	10.5 .. 105	33.9 - 339
K-factor (pulses per litre)	4.317	3.446	2.60	1.14
Litre per pulse (1/K)	0.231	0.290	0.385	0.877

### T-pieces - lines with an imperial diameter

Article description	T-piece GF for flow sensor GF2536-P0, imperial		
Article number	750781	750782	750783
Line diameter, internal (")	2.5	3	4
Measuring range (m <sup>3</sup> /hr) at a flow rate of 0.3 .. 3 m/s and lines of pressure class comparable with PN16	3.42 .. 34.2	4.93 .. 49.3	8.76 .. 87.6
K-factor (pulses per litre)	11.359	7.04	3.964
Litre per pulse (1/K)	0.088	0.142	0.252

Article description	T-piece GF for flow sensor GF2536-P1, imperial
Article number	750784
Line diameter, internal (")	6
Measuring range (m <sup>3</sup> /hr) at a flow rate of 0.3 .. 3 m/s and lines of pressure class comparable with PN16	19.7 .. 197
K-factor (pulses per litre)	2.199
Litre per pulse (1/K)	0.455



For different configurations, a K-factor calculator is available at [www.gfsignet.com](http://www.gfsignet.com).

## Filters

### Filter types

Use filters to filter organic dirt and solid particles out of the water. The choice of a sand filter and/or screen filter will depend on the quality of the supply water and the irrigation system requirements associated with the crop.

#### Sand filter

Use a sand filter if the supply water contains large amounts of organic dirt such as algae or plant remnants.

In general, the following operational conditions apply to a sand filter:

- The flow rate of the water through the sand filter is approx. 40 .. 50 m/h.
- The rinse water speed must be approx. 40 .. 50 m/h to achieve an expansion of around 15 % in the bed of sand via an additional backwashing pump.
- The size of sand grains is approx. 1 .. 2 mm.
- The thickness of the bed of sand is approx. 40 cm.

Other points to consider:

- On account of the hydraulic resistance, always position a sand filter at the discharge side of pump.
- In the event of a pressure difference of approx. 0.5 bar over the bed of sand, the sand filter must be rinsed. To do this, you require an additional backwashing pump.
- A multi-layer or multimedia filter can be used for large quantities of suspended particles, such as a filter with layers of anthracite, sand and gravel. For more information, please consult the sand filter supplier's manual.
- If a standstill of the unit during the backwashing of the filter is a problem, consider multiple filters connected in parallel. In this way there is always enough filter capacity if one of the filters is being backwashed.

#### Screen filter

Use a screen filter ('sieve filter') when the supply water contains a large number of hard and coarse particles.

In general, the following operational conditions apply to a screen filter:

- The flow rate through the filter must be adjusted to the type of filter.
- It must be possible to clean the filter automatically or manually during use.
- The filter must be made from SST or a synthetic material with a passage size < 75 .. 500 µm, depending on the type of supply water and type of irrigation system (dripper or sprinkler).



- Clean filters on a regular basis. The frequency depends on the degree of contamination of the supply water. Consult the user instructions or contact the supplier of the filter concerned.
- If the filter is installed on the distribution side of the unit, a dirt filter with a maximum passage size of 2 mm must be installed on the supply side.

Because a screen filter usually has a relatively coarse mesh size (especially if it is a dirt filter), the hydraulic resistance is low and the filter can also be positioned on the suction side of the pump. On account of the hydraulic resistance, a fine-meshed screen filter must be positioned on the discharge side of the pump.

### **Position of the filter relative to the unit**

There are many factors that determine whether a filter should be positioned on the supply side, on the distribution side or possibly on both sides of the unit. Some considerations:

- The smaller the openings on the sprinklers or drippers of the irrigation system, the easier it is for them to become clogged and the more important it is to ensure good filtration.
- Although it may seem logical to fine filter the supply water (thus protecting both the unit and the distribution system against particles), it is often better to position a relatively coarse filter (screen filter) on the supply side of the unit and a fine filter on the distribution side. This is because particles can also be produced in the unit, for instance as a result of algae growth or sediment or the depositing of fertilisers (especially when the unit is at a standstill). In addition, a fine filter may cause problems with the pump on the unit on account of the high hydraulic resistance.
- If recipes are changed frequently, a sand filter on the distribution side will be a disadvantage. This is because the sand filter will have to be frequently rinsed, resulting in a repeated loss of irrigation water.

## Operating software

Refer to the relevant process computer software manual.

## Commissioning the dosing unit

Commissioning is described in the software manual of the relevant process computer and is dependent on the software version used. See chapter *Procedures > Commissioning the dosing unit*.



---

## User settings

Once the unit has been configured, filled with water, the irrigation has been tested and the EC and pH controls have been set, the final user settings follow (which can subsequently be changed by the user at any time). There is a large number of possible settings depending on the model, configuration and crop that have been selected. It is therefore not possible to provide standard settings in this manual. Generally speaking, it is a question of:

- division of the irrigation valves and linking them to the start programs;
- recipes for the various irrigation valves (which fertiliser tanks are to be used for dosing and in what ratio, the EC value and pH value and the quantity of irrigation water per irrigation cycle);
- start programs (criteria for starting and stopping the irrigation cycle).

The user must subsequently be able to adjust these settings himself. The settings are therefore described in [Operation \(page 64\)](#).

The software manual for the process computer concerned contains a comprehensive description of all possible user settings.

## Delivery to the user

1. Demonstrate the unit to the user. When doing so explain:
  - what the operating options are;
  - the action to be taken by the user in the event of faults;
  - what maintenance is to be carried out by the user and what must be left to the installer/service engineer.
2. Hand over the unit (user) manual and - if required - the process computer (user) manual.
3. Hand over the remaining documentation containing (maintenance) information for the user, such as the documentation for the system pump.

## Operation



- Make sure that you understand the [Safety \(page 7\)](#) instructions before operating the unit.
- Carry out periodic maintenance in accordance with the preventative maintenance schedule (see [Maintenance and repair \(page 72\)](#)).

## Process phases

The process computer recognises the following process phases (depending on the software used):

1. Rest: the pump(s) are at a standstill and the irrigation valves and flush valve are closed. The hydronic part of the system is filled with irrigation water. The process computer waits until a start condition is met.
2. Pre-purge: the system pump is running and the flush valve is open so that the contents of the main irrigation line are discharged. At the same time, the unit prepares irrigation water so that the old irrigation water in the system is replaced by new irrigation water. This phase can be gone through when changing the recipe or if the system has been idle for a long period as a result of which the quality of the irrigation water in the system is no longer clear.
3. Operation: the system pump is running and the fertiliser solution is being supplied to a stock tank (indirect distribution method) or to the valve sections (direct distribution method). In the latter case the irrigation valves are controlled open by or via the unit according to the set conditions. At the same time, the unit prepares new fertiliser solution.
4. Post-purge: the supply pump, if fitted, stops, the valves in the distribution system close (with the direct distribution method) and the dosage valves close. The system pump continues to run for 3 s to rinse the dosing channel. This prevents sediment forming in the dosing channel. After the post-purge the unit returns to the idle phase.

The pre-purge and post-purge phases can be skipped if desired.

## Turning the unit on and off

The unit can be switched on and off electrically using the main switch. In principle, however, the unit must remain on constantly, unless there is a specific reason for switching the unit off. The running program can be interrupted via the operating software (see [Setting the unit to maintenance mode \(page 73\)](#)).

## Emergency stop

-  It is strongly recommended that an emergency stop is provided which makes all electrical equipment in the system free of electricity simultaneously. Position the emergency stop feature close to the unit.

Pressing the emergency stop has the same result as a power supply failure.

## Power supply failure

In the event of an interruption to the power supply (or when switching off, using the emergency stop for instance) the software settings and date and time are retained: the settings are saved automatically.

After the loss of power, the process computer resumes the process at the point where it stopped when the power was lost.

- 
  - Because the system pump stops prematurely during a power supply failure, the dosing channels will not be post-purged and a sediment may be formed. When the power has been restored, check therefore that the dosing channels are still functioning correctly.
  - When the power has been restored, check if there are any alarms.
  - If the power is lost for too long, you must use an alternative method to irrigate the crop.

## Topping-up fertilisers and acid or lye



If the system is equipped with low level switches on the fertiliser tanks, the unit generates an alarm if the fertiliser tank is in danger of becoming empty. However, it is best not to wait for this and to top-up the fertiliser tanks early:

- If there is a single fertiliser tank for the fertiliser concerned: interrupt the program that is running (refer to [Setting the unit to maintenance mode \(page 73\)](#)).  
If there are two fertiliser tanks for the fertiliser concerned: open the valve on the full fertilizer tank that has already been prepared and close the valve on the fertiliser tank that is almost empty.
- Fill the almost empty fertiliser tank with a known quantity of fresh water.
- Add a quantity of solid or concentrated fertiliser(s) or acid or lye that is appropriate to the quantity of water.
- Stir the contents of the fertiliser tank with an electric mixer until all solid matter has been dissolved and the solution is homogeneous.
- If you interrupted the program in step 1: resume the program.

- 
  - If you change the concentration of a solution in a fertiliser tank, then also adjust the recipes for that fertiliser tank. It may also be necessary to readjust the EC control (for a different concentration of fertiliser) or the pH control (for a different concentration of acid or lye).
  - If you are going to use higher concentrations, then take account of the highest concentration to which the equipment is resistant. This applies above all to the acid channel.

## Adjusting the user settings

There is a large number of possible settings depending on the model, configuration and crop that have been selected. The software manual for the process computer concerned contains a comprehensive description of all possible user settings. Broadly speaking, it is a matter of:

- division of the irrigation valves and their linking to the start programs;
- recipes for the various irrigation valves (which fertiliser tanks are to be used for dosing and in what ratio, the EC value and pH value and the quantity of irrigation water per irrigation cycle);
- start programs (criteria for starting and stopping the irrigation cycle).

Operation is described in the software manual for the relevant process computer (Connex or Compass) and depends on the software version used. See chapter *Procedures > Operating the dosing unit*.



Make (or arrange to be made) a back-up of all settings before adjusting them.



The EC value and the concentration of fertilisers are directly related to each other. The EC value has nothing to do with the nature and mixing ratio of the fertilisers however. The recipe indicates which fertilisers should be dosed in what ratio. The EC setting determines the quantity of fertiliser to be dosed in total. If you use supply water with an EC value that is too high it is possible that no fertilisers or a very small quantity of fertilisers will be dosed.

## Taking out of operation



Take the unit (and the rest of the system) out of operation for longer periods – such as winter – as follows:

1. Take the planned taking out of operation into account in your stock planning. Use up the stock to the extent possible.
2. Operate the unit manually to suction and – diluted with supply water – blow off the last remnants from the tank.
3. Spray the inside of the fertiliser tanks clean using water. Operate the unit manually to suction the rinse water out of the fertiliser tanks and in doing so rinse the lines, filters and the unit.

 The 'low level' protection in the mixing tank will be switched off when the pump is operated manually. The pump will therefore continue to be on even when the mixing tank has been pumped dry. Therefore, switch the pump off in good time so that it does not run dry.

4. Stop the supply of supply water and blow off the contents of the mixing tank until the minimum level is reached. Then set the pump switch to off.

 Leave the unit on: switching off leads to alarm messages and possible faults from the process computer.

5. Drain the branch line to the venturis by opening the drain valve below the EC sensors.
6. Clean the filters.
7. Clean the EC sensors.
8. Clean the pH sensors (if fitted) and place them in the storage liquid.
9. Clean the flow sensor (if fitted).
10. If there is a risk of freezing, drain the water supply system and the water distribution system.
11. If there is a risk of freezing in the room where the unit is set up:
  1. Drain the system pump (if fitted) and the supply pump (refer to the manuals for the pumps concerned).
  2. Remove the remaining water by unscrewing the lines on the unit or suctioning-off the water.
  3. Disconnect the pH sensors in the cabinet and store them with the glass membrane in storage liquid in a frost-free location.
12. Preferably, cover the unit with a tarpaulin.

Taking back into operation is, in principle, the same as the first commissioning. However, certain actions, such as configuring the I/Os, can be skipped.

# Troubleshooting



Certain activities may only be performed by authorised installers/service engineers because they require specialist knowledge and skills. These activities are indicated by "Installer" in the table below.

Problem	Possible cause	Solution(s)
The unit does nothing	The electrical supply is off.	<ul style="list-style-type: none"> <li>Ensure that the unit is connected and the main switch is on.</li> <li>Ensure that the external emergency stop (if fitted) is not depressed.</li> <li>Ensure that the fuse group to which the unit is connected is switched on.</li> <li>Installer: reset the circuit breaker in the cabinet.</li> </ul>
	The power supply to the unit is defective.	<ul style="list-style-type: none"> <li>Installer: check the internal fuses.</li> <li>Installer: replace the power supply.</li> </ul>
	An internal circuit is defective.	Installer: determine which circuit is defective and replace it.
The system pump does not start	The pump switch is off.	Ensure that the pump switch is set to automatic.
	The motor protection has been triggered.	Installer: reset the motor protection in the cabinet
	An alarm has been activated.	Check which alarm is involved and take action accordingly.
	There is a defect in the circuit that controls the pump motor.	Installer: determine what is defective and replace the defective components.
The system pump runs dry.	The low level switch in the mixing tank is defective.	Installer: check the low level switch and replace if necessary. In addition, check that the pump has not been damaged by running dry.
Supply water is not entering the mixing tank.	There is no supply water.	<ul style="list-style-type: none"> <li>Installer: check the supply pump (if fitted).</li> <li>Installer: check the supply valve (if fitted).</li> <li>Ensure that the filter in the supply line is clean.</li> </ul>
	The control float is defective.	Installer: check if water is flowing to the control float via the control line. Replace the control float if necessary.
	The filling valve is defective.	Installer: replace the filling valve.
The mixing tank overflows.	The control float is not correctly adjusted.	Installer: readjust the control float.
	The control line (of the control float) is leaking.	Installer: replace the control line.
	The filling valve is leaking or is defective.	Installer: replace the filling valve.
	The non-return valve in the main irrigation line is not functioning correctly.	Installer: clean the non-return valve. Replace the valve if this does not resolve the problem.
While preparing irrigation water the manometer on the pipe-work to the venturis indicates a pressure that is too low.	The discharge valve is open or there is a (major) leak in the distribution system.	<ul style="list-style-type: none"> <li>Ensure that the discharge valve is closed.</li> <li>Installer: check the distribution system for leaks, and repair them if necessary.</li> </ul>
	The system pump is turning in the wrong direction.	Installer: swap 2 phases of the mains power supply (disconnect electrical power first!)
	There is air in the system pump.	Bleed the system pump (refer to the documentation for the pump concerned).
	The dirt filter on the unit is blocked.	Clean the dirt filter.

Problem	Possible cause	Solution(s)
A fertiliser (or acid or lye) is not being dosed.	The level in the fertiliser tank is too low, causing air to be drawn in.	Ensure an adequate level in the fertiliser tank. Then ensure that the air is bled from the fertiliser line.
	A valve in the fertiliser line (if fitted) is closed.	Check whether the valve or valves in the fertiliser line are open.
	There is an air bubble in the fertiliser line.	Ensure that the air bubble is bled from the line.
	The dosage valve does not open.	<ul style="list-style-type: none"> <li>Check the software settings (for instance whether the fertiliser is included in the recipe).</li> <li>Installer: check the circuit that controls the dosage valve. Replace any defective components.</li> <li>Installer: Check the dosage valve. Replace it if necessary.</li> </ul>
	There is no flow, or an insufficient flow, of water through the venturi.	Installer: check if the same applies to all venturis (by looking under the lid of the mixing tank). If the flow rates are equally low from all venturis, then check the pressure shown by the manometer on the pipe-work to the venturis. If only the flow rate from the venturi concerned is too low, the nozzle of this venturi may be blocked.
	A filter in the fertiliser line is blocked.	Clean the filter.
The desired EC value is not being achieved.	There is a leak in the fertiliser line or in the connection between the dosage valve and the venturi allowing air to be suctioned-in.	Installer: check the pipe-work for leaks.
	The desired value is higher than the value that can be achieved with the fertiliser solutions.	<ul style="list-style-type: none"> <li>Correct the set value.</li> <li>Increase the concentration of the fertiliser solutions.</li> </ul>
	The EC value of the nutrient recipe has been incorrectly set.	Prepare the irrigation water manually according to the quantities in the nutrient recipe and measure the EC value of the mixture. Enter this value as the EC value for the nutrient recipe.
	The set value and the nutrient recipe are correct, but the concentration of one or more fertiliser solutions is too low.	Ensure that the concentrations of the fertiliser solutions are correct.
	The set value is correct, but is lower than the EC value of the supply water.	Increase the quantity of fresh water compared to drain water (if applicable).
	A fertiliser is not being dosed.	See the solutions for the problem 'A fertiliser (or acid or lye) is not being dosed'.
	The EC sensors are dirty.	Installer: clean the EC sensors.
The EC value swings wildly and "overshoots".	The P/I-factors of the EC control are set to a value that is too low.	Installer: reset the P/I-factors.
	The set value of the nutrient recipe EC is incorrect.	Installer: correct the nutrient recipe EC.

Problem	Possible cause	Solution(s)
The desired pH value is not being achieved.	The desired value is unattainable.	<ul style="list-style-type: none"> <li>Correct the set value.</li> <li>Check if an incorrect tank has been connected, which is causing lye to be mistakenly dosed instead of acid or acid instead of lye.</li> <li>Check in the software if lye is mistakenly being dosed instead of acid or acid instead of lye.</li> <li>Increase the concentration of the acid or lye.</li> </ul>
	The nutrient recipe has been set incorrectly.	Adjust the quantity of acid or lye in the nutrient recipe, taking into account the quantity of bicarbonate in the supply water.
	The set value and the nutrient recipe are correct, but the concentration of the acid or lye solution is too low.	<ul style="list-style-type: none"> <li>Check if lye is mistakenly being dosed instead of acid or acid instead of lye.</li> <li>Ensure that the concentration of the acid or lye solution is correct.</li> </ul>
	The acid or lye is not being dosed.	See the solutions for the problem 'A fertiliser (or acid or lye) is not being dosed'.
	The pH sensors are dirty or worn out.	<ul style="list-style-type: none"> <li>Clean the pH sensors.</li> <li>Installer: replace the pH sensors if cleaning does not resolve the problem.</li> </ul>
	The P/I-factors of the pH control are set to a value that is too low.	Installer: reset the P/I-factors.
The pH value swings wildly and "overshoots".	The concentration of acid or lye in the acid or lye tank is too high.	Reduce the concentration in the acid or lye tank.
	The quantity of acid or lye in the recipe is set too high.	Reduce the quantity of acid or lye in the recipe.
	The supply water contains too little bicarbonate.	<ul style="list-style-type: none"> <li>Installer: install a pre-treatment system for the supply water (see <a href="#">Supply water quality (page 82)</a>).</li> <li>Install a flow rate ratio control to mix the supply water with another water source that contains the correct amount of bicarbonate.</li> </ul>
	The P/I-factors of the pH control are set to a value that is too high.	Installer: reset the P/I-factors.
	At least one of the pH sensors is not functioning (correctly).	Calibrate the pH measurement.
EC alarm or pH alarm	The alarm threshold has been set incorrectly.	Correct the alarm threshold setting.
	At least one of the two sensors is dirty or defective.	<ul style="list-style-type: none"> <li>Installer: check the sensors.</li> <li>Clean the pH sensors (if necessary) and perform a new calibration.</li> <li>Installer: clean the EC sensors (if necessary) and perform a new calibration.</li> <li>Installer: replace the suspect sensor(s) if this does not resolve the problem.</li> </ul> <p>A measuring case with a reference pH meter and a reference EC-meter (the meters are also available separately) is available for checking pH sensors and EC sensors and for measurements outside of the unit. Calibration liquids and storage liquids are available separately.</p>
Flow alarm	The alarm threshold has been set incorrectly.	Correct the alarm threshold setting.
	The flow sensor (if fitted) is not set correctly.	Installer: check the flow sensor settings.
	The flow sensor is dirty or defective.	<ul style="list-style-type: none"> <li>Clean the flow sensor.</li> <li>Installer: replace the flow sensor if cleaning does not resolve the problem.</li> </ul>
	There is a leak in the main irrigation line or in a valve section.	Installer: trace the leak and fix it.
The plants receive more water than the set amount.	The flow sensor (if fitted) is dirty or defective.	<ul style="list-style-type: none"> <li>Clean the flow sensor.</li> <li>Installer: replace the flow sensor if cleaning does not resolve the problem.</li> </ul>



---

<b>Problem</b>	<b>Possible cause</b>	<b>Solution(s)</b>
Some irrigation valves no longer open.	The fuse of the relevant fuse group on the I/O board has burned out.	Installer: replace the defective fuse.
Analysis shows that the fertiliser concentrations do not match the recipe.	The dosage valves are supplying a flow rate that differs from that expected by the software.	Installer: readjust the dosage valve(s).

## Maintenance and repair



- Carry out periodic maintenance in accordance with the preventative maintenance schedule.
- Some maintenance activities may only be performed by authorised Priva installers/service engineers who have received product-specific training from Priva. This is indicated in the preventative maintenance schedule.
- Switch the unit off using the main switch before carrying out any maintenance work. If the unit has to remain on within the scope of the maintenance work take extra care.
- Only use original Priva spare parts.

## Preventative maintenance schedule

Minimum frequency	Action	To be carried out by	Explanation
always	be on the alert for leaks and abnormal noises (from the pump(s))	user	
weekly	check quantity of irrigation water to plants	user	1. For each irrigation valve, place a number of drippers in plastic beakers. 2. After the irrigation cycle, add the content of the beakers to a measuring beaker and read the volume. 3. Divide this volume by the number of beakers to determine the average volume per dripper.
	keep the unit and surrounding area clean	user	
monthly	clean dirt filters and other filters	user	
	check system pump pressure (via manometer on pipe-work to venturis)	user	Test with system pump running and normal consumption of irrigation water. See the pump documentation for the correct pressure.
	check pH sensors	user	
annually	flow sensor	user	
	check EC sensors	installer / service engineer	See <a href="#">EC sensor (page 44)</a> .
	clean rotameters on the dosing channels	installer / service engineer	See <a href="#">Cleaning the dosing channel rotameter (page 55)</a> .
	check the operation of the dosing channels	installer / service engineer	
	check low level switch in mixing tank	installer / service engineer	See <a href="#">Mixing tank low level switch (page 47)</a> .
	check control float in mixing tank	installer / service engineer	See <a href="#">Control float (page 48)</a> .
	check filling valve	installer / service engineer	
depending on the sensor	maintain other sensors that are connected to the unit (such as a light sensor)	depending on the sensor	Refer to the documentation for the sensor concerned.

---

## Setting the unit to maintenance mode

### Levels of setting to maintenance mode

The unit has be taken out of operation for maintenance. This can be done at three levels, depending on the nature of the maintenance:

1. Take the unit out of operation software-wise: this is necessary for maintenance where the software plays a role, such as calibrating sensors.
2. Take the system pump (and supply pump, if present) out of operation by switching off the pump switch(es): this is necessary for maintenance where the pumps absolutely must not start operating, such as when cleaning the dirt filter or calibrating the pH measurement.
3. Switch off the unit by setting the main switch to off: this is necessary for maintenance where the cabinet has to be open or where electrical parts may become wet, such as replacing electrical components and cleaning the exterior.



Please note that switching off the unit leads to alarm messages and possible malfunctions of the external process computer.

Set the unit to maintenance mode in ascending levels, not only the level concerned. For example, for level 2, first perform level 1 and then level 2.

### Cleaning the exterior of the unit

1. Turn off the main switch of the unit.
2. Clean the exterior of the unit:
  - Remove dust using a soft brush.
  - Wipe-down the surfaces with a damp cloth.



- Do not use aggressive or abrasive cleaners: they may damage the plastic. Use warm water only, with a few drops of washing-up liquid if necessary.
- Make sure that no water runs into the electrical components. For example, do not spray water onto the unit and thoroughly wring out the cleaning cloth before use.
- Do not press too hard on the operating panel / display and the keyboard (if fitted) when removing dirt.

3. Put the unit back into operation.

### Updating the software

Refer to the relevant software manual.

## Disposal of waste equipment

The unit must be disposed of as follows at the end of its service life:

1. Take the system out of operation (see [Taking out of operation \(page 67\)](#)).



It is important that the entire system is free from chemical substances and has been drained.

2. Disconnect the unit from the electricity network.
3. Disconnect all lines.
4. Loosen the fertiliser hoses or saw through the fertiliser pipes (whichever is applicable).
5. Use a fork-lift truck to load the unit onto a lorry (see [Transport and storage \(page 20\)](#)).
6. Take the unit to an approved collection centre for waste electrical equipment.



The equipment is marked in accordance with European Directive 2002/96/EC relating to waste electrical and electronic equipment (WEEE):



The mark indicates that the equipment cannot be disposed of with other household waste at the end of its service life. To prevent possible harm to the environment or to human health from uncontrolled waste disposal the equipment must be kept separate from other types of waste and be recycled in a responsible manner, so that the sustainable reuse of material sources is stimulated.

# Appendices

## EC Declaration of Conformity



The manufacturer:

Name of manufacturer Priva B.V.  
 Manufacturer's address Zijlweg 3  
 2679 LC De Lier  
 P.O. Box 18  
 2679 ZG De Lier  
 The Netherlands

declares the product:

Product name NutriFlex  
 Model/type Substation  
 Function Fertiliser dosing unit for the horticulture industry

is in conformity with the following European Directives:

- Low Voltage Directive 2014/35/EU

and conforms to the following harmonised European standards:

NEN-EN-IEC 61010-1:2014	Safety requirements for electrical equipment for measurement, control, and laboratory use - Part 1: General requirements
NEN-EN-IEC 62368-1	Audio/video, information and communication technology equipment - Part 1: Safety requirements

The technical file was compiled by the R&D department of Priva B.V.

The Netherlands, De Lier, February 2012

M. Prins  
 Managing Director

## Technical specifications

### Technical specifications - general

	NutriFlex with 300 l mixing tank	NutriFlex with 850 l mixing tank <sup>1)</sup>
Article number	depending on version, see price list (for dealers)	
Principle of operation	open mixing tank	
Fertiliser mixing principles	A + B principle (equal quantities of fertilisers) ABC-principle (adjustable ratio of fertiliser quantities)	
Irrigation capacity	5 – 65 m <sup>3</sup> /h net (depending on the selected system pump) 0.5 – 6.5 ha with direct irrigation (depending on the selected system pump)	65 – 110 m <sup>3</sup> /h net (depending on the selected system pump) 6.5 – 11 ha with direct irrigation (depending on the selected system pump)
Possible types of dosing channels	<ul style="list-style-type: none"> <li>• 300 l/h dosing channel (with dirt filter and without rotameter, or with dirt filter and rotameter)</li> <li>• 600 l/h dosing channel (with dirt filter and without rotameter, or with dirt filter and rotameter)</li> <li>• double dosing channel (with dirt filters and without rotameters, or with dirt filters and rotameters, occupies 2 adjacent positions for dosing channels)</li> <li>• 38% acid dosing channel (50 l/h)</li> </ul> <p>As a custom solution:</p> <ul style="list-style-type: none"> <li>• 100 l/h dosing channel (with dirt filter and without rotameter, or with dirt filter and rotameter)</li> <li>• low volume dosing channel (2 or 8 l/h)</li> <li>• triple dosing channels</li> </ul>	<ul style="list-style-type: none"> <li>• 600 l/h dosing channel (with dirt filter and without rotameter, or with dirt filter and rotameter)</li> <li>• double dosing channel (with dirt filters and without rotameters, or with dirt filters and rotameters, occupies 2 adjacent positions for dosing channels)</li> <li>• 38% acid dosing channel (50 l/h)</li> </ul> <p>As a custom solution:</p> <ul style="list-style-type: none"> <li>• 100 l/h dosing channel (with dirt filter and without rotameter, or with dirt filter and rotameter)</li> <li>• low volume dosing channel (2 or 8 l/h)</li> <li>• triple dosing channels</li> </ul>
Maximum number of dosing channels	9 for fertilisers and 1 for acid or lye	
Volume of mixing tank	300 l gross / 270 l net	850 l gross / 750 l net
Permissible supply water pressure	2 – 4 bar	
Pumps	In the calculation of the installation, the system pump and optional supply pump are selected on the basis of various criteria. Pumps are available with various capacities and for various mains voltages and mains frequencies. <sup>2)</sup>	
System pump protection	<ul style="list-style-type: none"> <li>• dry running protection based on low level switch in the mixing tank</li> <li>• overload protection based on motor protection</li> </ul>	
Supply pump protection (if fitted)	overload protection based on motor protection (no dry running protection)	
Manometer for visual pressure check	checking of drive water pressure on venturis (pressure side of system pump)	
Regulations and standards with which the unit complies	see the EC Declaration of Conformity	

<sup>1)</sup>Capacities greater than approximately 75 m<sup>3</sup>/h require a custom solution.

<sup>2)</sup>In order to make a choice, dealers can consult the specifications in the price list. The configuration ultimately supplied and the associated most relevant specifications are summarised in the test report ("Product Delivery" form) that is supplied with the unit. The manuals of the selected components are also supplied with the unit.

## Technical specifications - mechanical

	NutriFlex with 300 l mixing tank	NutriFlex with 850 l mixing tank
Dimensions	see figure <a href="#">Dimensions of NutriFlex (with 300 l mixing tank) (page 78)</a>	
Dimensions in packaging (L x W x H)	183 x 137 x 165 cm	227 x 172 x 195 cm
Mass (lowest mass with lightest system pump and without supply pump, highest mass with heaviest system pump and heaviest supply pump)	400 – 620 kg	approx. 570 kg
Materials which (may) come into contact with chemical substances	<ul style="list-style-type: none"> <li>• PE: mixing tank</li> <li>• PVC: lines and screw couplings</li> <li>• PP: dirt filters of dosing channels</li> <li>• PA-12: tube of rotameter<sup>1)</sup></li> <li>• fluoropolymers: PVDF, PTFE and FPM for 38% acid dosing channel<sup>1)</sup> and PTFE for float body of rotameter<sup>1)</sup></li> <li>• NBR: O-rings of rotameters<sup>1)</sup> and filters of dosing channels</li> <li>• EPDM: membranes and seals of dosage valves</li> <li>• Stainless steel: frame, pumps and fixing equipment, AISI316 for housings of dosage valves and AISI329 for float body of rotameter<sup>1)</sup></li> <li>• powder coated steel: pumps and cabinet</li> </ul>	

<sup>1)</sup>If present.

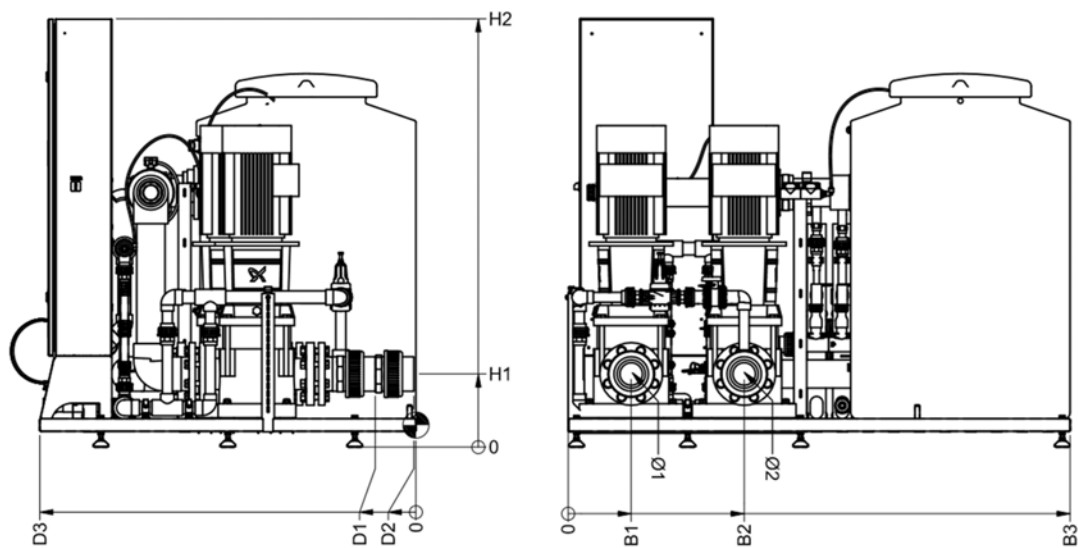

**Dimensions of NutriFlex (with 300 l mixing tank)**



Sys. pump <sup>1)</sup>	Supply pump	Ø1 (mm) <sup>2)</sup>	Ø2 (mm) <sup>2)</sup>	B1 (mm)	B2 (mm)	B3 (mm)	D1 (mm)	D2 (mm)	D3 (mm)	H1 (mm) <sup>3)</sup>	H2 (mm) <sup>4)</sup>
<b>NutriFlex with 300 l mixing tank</b>											
CR15	CR15	63	63	200	560	1600	259	108	1200	184	1366
CR15	-	63	63	200	560	1600	122	108	1200	145	1366
CR20	CR20	63	63	200	560	1600	259	108	1200	184	1366
CR20	-	63	63	200	560	1600	122	108	1200	145	1366
CR32	CR32	75	75	200	560	1600	207	29	1200	199	1366
CR32	-	75	75	200	560	1600	132	29	1200	151	1366
CR45	CR45	90	90	200	560	1600	124	10	1200	234	1366
CR45	-	90	90	200	560	1600	149	10	1200	159	1366
CR64	CR64	110	110	200	560	1600	80	2	1200	234	1366
CR64	-	110	110	200	560	1600	225	2	1200	209	1366
<b>NutriFlex with 850 l mixing tank</b>											
CR64	CR64	110	110	200	920	2070	362	244	1500	234	1500
CR64	-	110	110	200	920	2070	244	244	1500	209	1500
CR90	CR90	110	110	200	920	2070	377	259	1500	234	1500
CR90	-	110	110	200	920	2070	259	259	1500	209	1500

<sup>1)</sup>Not all the pumps in this table are included in the price list. They are, however, available on request.

<sup>2)</sup>Various metric and imperial adaptation rings are available for the screw coupling to connect to pipes of various diameters and pipes with screw thread.

<sup>3)</sup>In the event of a custom solution, depends on the system pump.

<sup>4)</sup>Depends on the adjustable legs of the frame.

### Technical specifications - electrical

	NutriFlex
Required mains voltage and mains frequency	The mains voltage and mains frequency must be specified on ordering. The following options are available: <ul style="list-style-type: none"> <li>• 200 VAC +/-10%</li> <li>• 400 VAC +/-10%</li> <li>• 440 VAC +/-10%</li> <li>• 460 VAC +/-10%</li> <li>• 480 VAC +/-10%</li> </ul> with a mains frequency of 50 or 60Hz.
Maximum power consumption	300 VA excluding system pump and any supply pump. The electrical power consumed by the pump(s) is, however, much greater (see specifications of pump(s)).

### Technical specifications - process computer

The process computer is described in detail in the hardware and software manuals of the relevant process computer. The table below only provides a summary of the aspects that are important for the fertiliser dosing unit.

	NutriFlex with Connext	NutriFlex with Compass
Process computer	external: Connext fertiliser dosing unit is a substation in the network of the process computer	external: Compass fertiliser dosing unit is connected to the I/Os of the process computer
Operation	remotely via external process computer	remotely via external process computer
Program cycle	day or week (other options depending on configuration, see software manual)	week with number of starts per day (see software manual for other options)
Number of valve groups or valves to be started independently of each other <sup>1)</sup>	equal to the number of set start programs	equal to the number of set start programs

	NutriFlex with Connex	NutriFlex with Compass
Number of periods per 24-hour period in which a start for a valve group or valve <sup>1)</sup> can be defined	6	4
Start based on <sup>2)</sup>	among other things time, temperature, radiation level, radiation sum, external control (for instance level in a tank) and manually (see software manual for all options)	among other things time, radiation level, radiation sum, external control (for instance level in a tank) and manually (see software manual for all options)
Stop based on <sup>2)</sup>	duration, quantity of irrigation water, external control (for instance level in a tank), manual and malfunction or alarm	duration, quantity of irrigation water, external control (for instance level in a tank), manual and malfunction or alarm
Number of recipes (a recipe includes, among other things, the settings for the desired EC and pH values)	depending on the selected configuration (see software manual)	8
Selection of fertiliser tank (tanks A1, B1, C1 etc. or tanks A2, B2, C2 etc.) <sup>2)</sup>	yes	no (if the option for selecting a supply water source is not applied, that option can be used with a small adjustment of the internal wiring for the selection of fertiliser tanks)
Mixing tank level reduction	yes	no
Balance level control (with A+B principle) <sup>2)</sup>	yes	no
Selection of supply water tanks or day storage tanks <sup>2)</sup>	yes	yes, maximum of 8 tanks
Irrigation water flow rate or volume measurement <sup>2)</sup>	yes	yes
Dosage can anticipate a change in irrigation water flow ('feed forward' control)	yes	no (there is a reaction to the change via 'feedback' control, but it is slower than via 'feed forward' control)
Control may take account of the number of irrigation valves that are open at the same time	yes	no
Drain measurement <sup>2)</sup>	yes, both volume and EC (and pH) of several drain measurements The actual moment of starting (after the start program has been launched) can be influenced based on the drain quantity.	no
Supply water from different sources can be mixed on the basis of EC or flow ratio <sup>2)</sup>	yes	no
EC correction based on light intensity <sup>2)</sup> (lower EC value if there is a lot of sun and a large amount of evaporation)	yes	no
Flush valve can be controlled automatically during a recipe change	yes	no
Backwashing program for sand filter <sup>2)</sup>	yes, up to 8 filters switched in parallel	yes, 1 filter
Registration of the measured values and settings	yes, with extensive reporting capabilities via Priva Office Direct (depending on selected configuration, see software manual)	yes, but without extensive reporting capabilities
Alarm functions and warning signal	various options (see software manual)	various options (see software manual)
Printer connection (for printing alarms and reports)	on process computer, not on the unit	on process computer, not on the unit
Available languages for software operation	see price list	see price list

<sup>1)</sup>In the Connex software, valve groups are linked to start programs, in the Compass software valves are linked to start programs.

<sup>2)</sup>To make use of these options, sensors and other components (such as I/O expansions) that are not supplied as standard may be required.

### Technical specifications - screw coupling adaptation rings

The unit is only supplied with the internal water pipes. The supply and drainage pipes for the units are not installed in advance, as the set-up is different in every room. To ensure an easy connection, the couplings are designed as screw couplings.

Each screw coupling (A) has an adaptation ring (B) into which the end of the pipe has to be glued. By default, a metric adaptation ring is supplied.

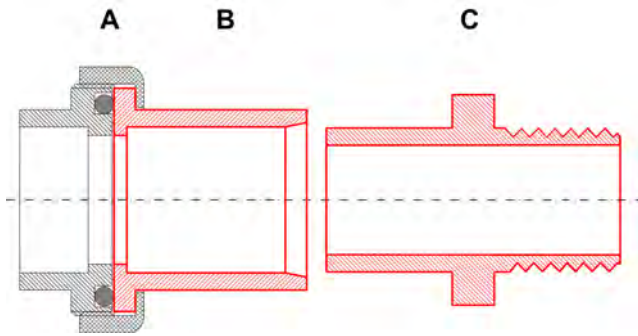

- A. screw coupling
- B. adaptation ring with smooth interior for glueing to the pipe (metric by default, or imperial as an option)
- C. imperial adaptation ring (to be glued into standard adaptation ring for joining pipe with internal imperial thread)

### Adaptation rings

For pipes with imperial diameters, Priva supplies the following adaptation rings (B):

Article number	751312	751313	751314	751326	751334
Internal diameter (")	1.5	2	2.5	3	4
Fits in screw coupling	Ø 50 mm	Ø 63 mm	Ø 75 mm	Ø 90 mm	Ø 110 mm

### Imperial adaptation rings

For pipes with internal thread, Priva supplies the following imperial adaptation rings (C) which can be glued into the metric adaptation ring (B):

Article number	751246	751232	751229	751238
External thread (")	1.5	2	2.5	3
Fits in standard adaptation ring of screw coupling	Ø 50 mm	Ø 63 mm	Ø 75 mm	Ø 90 mm

## Supply water quality

### Composition and pH value

The dosing unit adds acid or lye to the supply water to:

- regulate the pH value of the irrigation water;
- chemically mix (homogenise) the irrigation water in an optimum manner;
- allow a chemical reaction to take place (convert bicarbonate into carbon dioxide).

The pH value of the irrigation water must be between 5.2 and 6.2, depending on the crop and growing medium.

Supply water consists of (a combination of) rain water, drinking water, well water, downstream mill water, river water or reverse osmosis water, typically mixed with (disinfected) drain water. The variety of chemical elements in the supply water determine not only the composition and the pH value of the supply water but also whether or not the supply water can be used as irrigation water once fertiliser and acid or lye have been added using the dosing unit.

### Influence of bicarbonate

It is important that the quantity of  $\text{HCO}_3^-$  (bicarbonate) in the supply water is established by means of water analysis. Bicarbonate has a buffering effect on the pH value and affects the operation of the acid dosing control in the dosing unit:

- An optimum quantity of  $\text{HCO}_3^-$  in the supply water helps to ensure that plants receive irrigation water with a reliable and accurate pH value via the dosing unit. The correct pH value of the irrigation water is necessary for the good take up of fertilisers by the plant.
- An excessively low quantity of  $\text{HCO}_3^-$  causes the pH control to become unstable.
- An (excessively) high amount of  $\text{HCO}_3^-$  leads to an (excessively) slow chemical reaction in the mixing tank. Dosing acid neutralises  $\text{HCO}_3^-$ , with a quantity of  $\text{CO}_2$  (carbon dioxide) being generated. This  $\text{CO}_2$  must be released from the irrigation water in the open mixing tank via contact with the ambient air. The greater the quantity of  $\text{HCO}_3^-$ , the longer before the neutralisation reaction is completed. If the reaction is not completed within the exposure time in the mixing tank, a problem arises: the unit will indeed be supplying irrigation water with the desired pH, but there will still be  $\text{CO}_2$  in it. In the closed irrigation line this  $\text{CO}_2$  cannot be released into the ambient air, and reaches the plant. There it will be released into the ambient air, causing the pH to rise. In this case, the pH at the plants will not therefore be the same as the pH that was set on the unit.

The table below shows the limit values for the quantity of  $\text{HCO}_3^-$  and the qualification of the supply water. In some cases, the quantity of  $\text{HCO}_3^-$  in the water is also displayed as calcium carbonate ( $\text{CaCO}_3$ ), in which case it is usually quoted in mg/l. The corresponding values are included in the table.

#### ***Bicarbonate limit values and supply water qualification***

Quantity of bicarbonate ( $\text{HCO}_3^-$ )		Quantity of bicarbonate expressed as calcium carbonate ( $\text{CaCO}_3$ )		Supply water qualification
[mmol/l]	[mg/l] or [ppm]	[mmol/l]	[mg/l] or [ppm]	
< 0.10	< 6.1	< 0.050	< 5.0	Too low
0.10 – 0.50	6.1 – 30.5	0.050 – 0.250	5.0 – 25.0	Optimum
0.50 – 1.0	30.5 – 61.0	0.250 – 0.5	25.0 – 50	High
≥ 1.0	≥ 61.0	≥ 0.5	≥ 50	Too high

### Pre-treat supply water

On the basis of the concentration of  $\text{HCO}_3^-$ , it must be determined which measures or combinations of measures should be taken to pre-treat the supply water.

## Supply water with too low a concentration of bicarbonate

When using reverse osmosis water, but in some cases rain water also, too low a quantity of  $\text{HCO}_3^-$  ( $< 0.10$  mmol/l) may be deemed to exist in the supply water. Dosing acid may give rise to an unstable chemical reaction in the irrigation water.



This unstable reaction can be stabilised by taking one of the following measures, or a combination thereof:

- Add disinfected drain water, which typically contains bicarbonate, to the supply water (via an EC pre-control).
- Add a small amount of drinking water or spring water (1 – 2%) to the supply water by means of an electric valve with a low flow rate.
- Add a small quantity of bicarbonate to one of the fertiliser solutions. This can be done, for example, by replacing 1% of caustic potash with an equal quantity of potassium carbonate ( $\text{KHCO}_3$ ) or calcium carbonate ( $\text{K}_2\text{CO}_3$ ).

## Supply water with a high concentration of bicarbonate

When using well water, river water and drinking water, the supply water may sometimes contain a high concentration of  $\text{HCO}_3^-$  (0.50 – 1.0 mmol/l). Dosing acid may then result in there being insufficient time to neutralise the bicarbonate.



Stabilisation is possible by correcting the pH value of the supply water by accurately dosing a fixed quantity of acid per  $\text{m}^3$  of supply water using an acid dosing pump connected to an accurate litre counter.

## Preparing an acid supply



Add the acid to the water; never add water to acid.

## Determining the correct dilution

The dosing unit often has to dose acid to bring the irrigation water up to the correct pH value. The use of acid depends on:

- the pH of the supply water;
- the desired pH of the irrigation water;
- the nature and concentration of the acid neutralizing compounds in the supply water and in the fertiliser solutions.

In principle, very little acid is required for pH correction. In practice however, there are often substances in the supply water and in the fertiliser solutions which bind the acid (phosphate and bicarbonate). This results in a smaller change in the pH than would be expected based on the quantity of acid applied (this is known as 'buffering'). In order to achieve good pH-control it is therefore important that acid is used in a concentration that has been tailored to the concentration of buffer substances. After all:

- when the acid concentration is too low, even the maximum dosing flow rate will not be sufficient to achieve the desired pH value;
- when the acid concentration is too high, even the smallest possible dosing flow rate will swing the pH value severely and overshoot.

The best practice is to create an acid stock from a dilution of concentrated nitric acid. In order to achieve the optimum dilution, it is necessary to know the quantity of buffer substances in the supply water. Although most laboratory analyses reveal something about this, pre-calculating the precise dilution that is required continues to be problematical. Therefore, in practice the dilution required is determined by starting with a common concentration, for instance 3% (weight percent). If it turns out that the pH is not corrected fully or quickly enough, the concentration must be increased. If it turns out that the pH overshoots and swings dramatically, the concentration must be decreased. In addition, if the quality of the supply water is not constant, the acid concentration must be adjusted every now and then. Always keep a record of which dilution is being used, so that a new acid stock can easily be prepared at the same dilution.



The maximum concentration of (nitric) acid depends on the type of dosing channel used. A higher concentration reduces the service life of the components.

## Creating a standard dilution of 3%

Nitric acid is often supplied in 20 l barrels at a concentration of 38%, 53% or 68% (weight percent). To dilute this to 3% (weight percent), it is necessary to mix the contents of the barrel with 315, 470 or 640 l fresh water. Always pour the acid into the water instead of the water into the acid, and always stir the mixture thoroughly to homogenise it.

### Example

Make a 3% dilution with a 20 litre barrel of 38% nitric acid:

1. Pour half of the required water into a barrel (e.g. one of 500 l) - in this case 147 litres of water.
2.  Use personal protective equipment to protect your skin and eyes.

Carefully pour the 20 litre barrel of 38% nitric acid into the barrel of water (without splashing or spilling).

3. Also pour the rest of the water, 147 litres, into the barrel.
4. Stir gently with an acid-resistant stirrer so that the acid is mixed well.

With a 20 litre barrel of 38% nitric acid (24.8 kg), 312 litres of 3% nitric acid can be made by first pouring 146 litres of fresh water into a barrel containing sufficient volume, then the 20 litres of nitric acid and then the remaining 146 litres of water.

With a 20 litre barrel of 53% nitric acid (26.7 kg), 470 litres of 3% nitric acid can be made by first pouring 225 litres of fresh water into a barrel containing sufficient volume, then the 20 litres of nitric acid and then the remaining 225 litres of water.

With a 20 litre barrel of 68% nitric acid (28.2 kg), 640 litres of 3% nitric acid can be made by first pouring 310 litres of fresh water into a barrel containing sufficient volume, then the 20 litres of nitric acid and then the remaining 310 litres of water.

## Terms and abbreviations



The list below states the abbreviations and terms relating to all disinfection units, purification units and fertiliser dosing units. Therefore, abbreviations and terms that do not apply to your specific unit and as a result are not used in this manual, may still be found in the list below.

Abbreviation / term	Explanation
A+B principle	A principle where fertiliser solutions are prepared manually in 2 (or possibly more) fertiliser tanks, in such concentrations that the unit has to mix them in equal quantities.
ABC principle	A principle where the unit mixes the fertiliser solutions from 3 (or possibly more) fertiliser tanks in the ratios as programmed in the recipe.
Anti-block	Chemical solution to clean the line walls of the distribution system periodically.
(to) Backwash a sand filter	Cleaning of a filter by flushing it with rinse water, against the normal direction of flow, with the dirty rinse water being discharged. Backwashing can periodically be performed automatically using electric valves and a rinse water pump controlled from the process computer.
(to) Backwash	Cleaning a filter by flushing it with rinse water, in counter flow, and draining away the dirty water. Backwashing can be done automatically using electric valves and a rinse water pump that are controlled by the process computer.
Balance level control	Control for the A+B principle that levels any differences in level in the emptying tanks over time. This allows to fill-up the tanks at the same time.
Change-over contact	Switch, switching sensor or relay with 2 positions: normally open (NO) and normally closed (NC). "Normally" refers to the idle position when the component has not been activated.
Direct distribution	The unit carries the irrigation water directly to the crop area and controls the irrigation valves.
Dirt filter	A wide mesh type of filter
(to) Discharge, discharge valve	Discharging irrigation water (e.g. to the sewer) via a (usually manually operated) discharge valve at the beginning of the main irrigation line. This can be necessary if the irrigation water is not of the desired quality (e.g. during the adjustment of the EC and pH controls).
Disinfect (disinfection)	Treating the water in such a way that the (pathogenic) micro-organisms can no longer reproduce. The micro-organisms are not necessarily killed. See also "sterilise".
Disinfected water	Water that has been disinfected by the water disinfection unit.
Drain measurement	Measurement of the volume of drain water over a specific time and of the EC value of the drain water (or measurement of one of both).
Dose	For UV light: the average intensity of the active part of the light to which the water is exposed during the residence time, expressed in mJ/cm <sup>2</sup> (intensity (W/cm <sup>2</sup> ) x time (s) = energy (J/cm <sup>2</sup> ). In order to produce more easily readable numbers, the figure for the energy is multiplied by 1000 and then expressed as mJ/cm <sup>2</sup> . The average intensity is calculated from the intensity measured with the UV sensor, the distance between the UV sensor and the quartz tube, the T10 value determined at the start of the production, the outside diameter of the quartz tube and the inside diameter of the chamber.
Drain water	Water that is not taken up by the plant and is then collected for reuse.
Drive water	Water that flows through the venturi's of the dosing channels to create a vacuum for suctioning fertiliser, or acid or lye solution.
EC	Electrical Conductivity, in the horticultural usually in terms of millisiemens per centimetre (mS/cm).
EC pre-control	Control to mix drain water and fresh water such that the supply water has the desired EC value. This EC value is a base for further increase of the EC value by fertiliser dosing.
Flowsensor	The flow sensor gives a number of pulses per unit of volume passed. The flow sensor is used to measure the volume passing through (flow).
Flash memory	Memory that retains data (such as settings), even after power switch-off or mains voltage failure.
Float switch	Switch installed in a water tank or silo. The float switch transmits a signal when the water reaches the same level as the float. (See also level sensor and level sensor)
(to) Flush, flush valve	Replacing the irrigation water in the main irrigation line by other/new irrigation water (e.g. after changing the recipe). Flushing takes place by opening the flush valve (usually controlled by the process computer) at the end of the main irrigation line and pumping the new irrigation water in the irrigation line.



Abbreviation / term	Explanation
Fresh water	Water having a relative low EC value (no or hardly any fertilisers), such as rain water, groundwater, drinking-water, well water and reversed osmosis water
HBC	High Breaking Capacity, a type of fuse
I/O	Input/Output
I/O module	Module with digital inputs, analogue inputs and/or digital outputs to which sensors, measuring equipment and actuators can be connected.
I/O net	Network where the Connex or Intégro process computer and the I/O modules exchange data.
Imperial	Refers to the British system of units, e.g. for dimensions (e.g. inches). This system is different from the metric system.
Indirect distribution	The unit supplies the irrigation water to a stock tank or silo. From there, a separate system handles the irrigation.
Irrigation water	Water to which fertilisers and acid or lye are added, so that it has the desired EC and pH value.
K-factor	Calibration parameter of a litre counter: the volume (in l) per pulse. This factor is not only determined by the design of the flow sensor, but also by the internal dimensions of the T-piece to which this sensor is screwed and the depth to which the sensor is inserted in the T-piece.
Level sensor	Sensor installed in a water tank or silo. The sensor provides an analogue signal, indicating the water level as a percentage. The level sensor must be calibrated on a regular basis. (See also level switch and float switch)
Level switch	Switch installed in a water tank or silo. The level switch transmits a digital signal when the water reaches a certain level. (See also level sensor and float switch)
Linear light sensor	A type of light sensor to measure sunlight in kilolux (klux) over the visible part of the spectrum (wave length 400 - 800 nm)
Litre counter	See "flowsensor".
Mixing tank level reduction	Anticipating by the process computer on a recipe change by stopping the preparation of new irrigation water on time. This causes the stock in the mixing tank to be used up to the minimum level and the new recipe being available within less time.
Motor protection	Electric protection, based on a thermal working principle, which switches off the (pump) motor when it consumes too much power. The motor protection can be reset after cooling down. The motor protection resides in the cabinet, not on the pump.
Nozzle	The part of a venturi or sprinkler that is responsible for the operation
NTC	Negative temperature coefficient, refers to a type of temperature sensor
P/I	Proportional/Integrating, refers to a type of control where the correction signal consists of a proportional component (correction signal directly proportional to the deviation) and an integrating component (correction signal increases the longer the deviation persists). The control is adjusted by the P and I factors.
pH	degree of acidity (negative logarithm of the concentration of acid particles (H <sup>+</sup> ))
PCB	Printed circuit board
PSD	Programmable system device, a chip into which system software is programmed, amongst other things
Radiation sum	Dose of sunlight (radiation intensity integrated over a period of time, in term of J/m <sup>2</sup> ) that is received over a specific period of time.
Report alarm/stop alarm	With a report alarm, an alarm is only reported. With a stop alarm, the process is also aborted.
(to) Rinse (a sand filter)	To fill up the sand filter with water so that the sand bed becomes homogeneous and the filter ready for use.
Rotameter	A type of flow meter that is visually readable. A rotameter is based on a float body that is pushed up by the upwards flowing liquid in a transparent tapered pipe.
Sand bed	The layer of sand in a sand filter
Section	Menu or window with settings and/or reports within the use interface of the Connex and Intégro software. The sections are uniquely coded (e.g. <i>I420.5</i> and <i>M430</i> ) and the data is arranged in tables with rows (lines) and one or more columns.
Selective disinfection	The reproductive capacity of only some of the types of micro-organisms is disabled (for instance, after selective disinfection fungi and nematodes can no longer multiply, but viruses may still be able to. As long as the corresponding viruses are not harmful to the crop, this is not a problem.) See also "total disinfection".
Settlement of sand filter	Filling a sand filter with water in such a way that the bed of sand is even and the filter is ready for use. The dirt that has come from the bottom of the sand filter after the settlement is transported to the drain water tank.

Abbreviation / term	Explanation
Silo, tank	More or less exchangeable terms for a construction to store liquid or other substances. Silos are constructed from corrugated sheets and are often open at the top. Tanks have smooth walls and can be closed at the top. Silos are often larger than tanks.
Softstarter	Electronic module to run up a (pump) motor in a controlled way, so that electrical and mechanical overload are avoided.
Solarimeter	A type of light sensor to measure sun radiation in W/m <sup>2</sup> over a wide spectrum (wavelength 300 .. 2500 nm).
Sterilising	Treating the water in such a way that all micro-organisms are killed. See also "disinfection".
Supply water	Water that flows to the unit. This water consists of fresh and/or drain water.
T10 value	UV permeability of the water to be disinfected over a distance of 10 mm, expressed in a percentage, compared to demineralised water, which is taken as a 100% reference.
Tank	Refer to "Silo, tank".
Total disinfection	The reproduction power of all types of micro-organisms is disabled (for instance, not just of fungi and nematodes but also of viruses). See also "selective disinfection".
UV-C	Ultraviolet light of category C (wavelength 200 – 280 nm)
Valve group	A group of irrigation valves that software opens or closes simultaneous or after each other in an irrigation cycle.
Venturi	A channel with a nozzle that generates a vacuum if drive water flows through. The vacuum causes suctioning of fertiliser, acid or lye solution.
Watchdog	Circuit or software that has to be reset periodically by the running software. If it is not reset then the software 'hangs'. The watchdog then ensures that the software is restarted so the software runs again.
Water hammer	Peak load (by increased pressure) of components of a water system, caused by a sudden standstill or strong direction change of the water flow (e.g. after the fast closure of a valve or after the starting of a pump, when the water 'hammers' against the end of a line that is not bled)



Priva (head office)  
Zijlweg 3  
2678 LC De Lier  
The Netherlands

See [www.priva.com](http://www.priva.com) for contact information of a Priva office or partner for your region.