



Manual

> OPERATING NUTRIFLEX



**Fertiliser dosing units
NutriFlex Substation**



Contact

Priva (head office)
Zijlweg 3
2678 LC De Lier
The Netherlands

See www.priva.com for contact information of a Priva office or partner for your region.

Article number: 3790066
Version: 00.002
Date: March 2020

© Copyright Priva B.V. All rights reserved.

No part of this publication may be reproduced, published or stored in a retrieval system without written prior permission of Priva.

This publication has been developed with care. However, the products shown may differ in dimensions and design from the actual products. Priva will not accept any responsibility for damages caused by any errors or deficiencies in this publication. Priva may modify its products and the associated manuals without prior notice. Priva advises to check product, installation, hardware and if present software on irregularities.

Priva owns the patents, patent applications, trademarks or other intellectual property rights regarding the products described in this publication. With this publication Priva does not grant the use of the aforementioned intellectual property rights. Product and company names this publication may not be used without the permission of Priva.

All Priva products and services are subject to the relevant Priva general terms and conditions. These general terms and conditions can be read and downloaded at www.priva.com/general-conditions.

Contents

About this manual	4
Aim and scope	4
Target groups and required competencies	4
Availability of the manual	4
Symbols in this manual	5
Safety	6
Safety - general	6
Safe handling of chemical substances	6
Electrical safety	7
Safety with mechanical parts	7
Safety with hot parts	8
Noise safety	8
Safeguards	8
Safety icons on the unit	9
Personal protective equipment	10
Product description	11
Functions and intended use	11
Preparing irrigation water	11
Correcting the pH value of irrigation water	11
Distributing irrigation water	12
Versions	12
Principle of operation	13
Construction	15
Controls	16
Pump switch	16
Main switch	16
Workplace	16
Type plate on the product	17
Warranty	18
Transport and storage	19
Installing and commissioning	20
Location and environmental conditions	20
Minimum free space around unit	20
Environmental requirements	20
Basic facility requirement	21
Operating software	22

Operation	23
Process phases	23
Turning the unit on and off	23
Emergency stop	24
Power supply failure	24
Topping-up fertilisers and acid or lye	24
Adjusting the user settings	25
Parts	26
pH sensor	26
Fitting the pH sensor	26
Calibrating the pH measurement	26
Cleaning the pH sensors	27
Technical specifications – pH sensor	28
Inline dirt filter	28
Cleaning the inline dirt filter	28
Filter of dosing channel	29
Cleaning the dosing channel filter	29
Flow sensor	29
Cleaning the flow sensor	30
Taking out of operation	31
Troubleshooting	32
Maintenance and repair	36
Preventative maintenance schedule	36
Setting the unit to maintenance mode	37
Levels of setting to maintenance mode	37
Cleaning the exterior of the unit	37
Disposal of waste equipment	38
Appendices	39
EC Declaration of Conformity	40
Technical specifications	41
Technical specifications – general	41
Technical specifications – mechanical	42
Technical specifications - electrical	43
Technical specifications - process computer	43
Technical specifications - pumps	45
Supply water quality	46
Preparing an acid supply	48

Terms and abbreviations	50
-------------------------------	----

About this manual

Aim and scope

This manual contains all of the information that is required to safely and correctly operate and maintain the fertiliser dosing unit. This manual will also allow you to effectively observe and resolve any faults.

The data and the illustrations in this manual relate to the various models of the fertiliser dosing unit. In addition, each fertiliser dosing unit has customer-specific features, which may differ slightly from the description in this manual. You can find details about this in the project drawings and documents that have been created specifically for your delivery.

For the sake of simplicity this manual uses the term 'unit' to refer to 'fertiliser dosing unit'.

Target groups and required competencies

Target group	Tasks and responsibilities	Training, knowledge and experience required
User management	ability to do the following with the unit: <ul style="list-style-type: none"> • operate • check in the event of a malfunction and resolve simple malfunctions • maintain it in accordance with the maintenance schedule (simple maintenance only) 	<ul style="list-style-type: none"> • general technical insight • knowledge of the crop's water requirement and fertiliser requirement • some knowledge of the characteristics and hazards of the chemical substances used in the water installations







Availability of the manual







This manual must be available in the workplace at all times for the personnel who operate and monitor the unit.

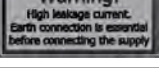



In addition to this manual, other relevant user manuals, such as the process computer software manual, must also be available.

Symbols in this manual

The following symbols may appear on the unit and in the manuals.

Warning symbols for specific hazards	
	danger: read the manual before switching the unit on
	corrosive chemical substance(s)
	hot surface
	live parts (danger of electrocution)
	UV light
	oxidising chemical substance(s)
	High leakage current! Earthing required for the connection of the power supply.

Prescriptive symbols	
	wear ear protection
	wear safety glasses
	wear ear protection and safety glasses
	wear non-permeable gloves that are resistant to chemical substances
	wear clean work clothes that cover as much of the skin as possible
	wear (safety) boots
	Read the device manual

Other symbols	
	danger (instruction to prevent physical injury, damage to health or damage to the environment)
	note (instruction to prevent problems or material damage)
	additional information or explanation
	tip

Safety



- Before starting to work with the product, read the entire manual so that you are familiar with all safety instructions and safety precautions.
- In addition, read any other manuals supplied with specific components.

Safety - general

- Only Priva approved installers/service engineers who have received product-specific training from Priva are allowed to install, configure, repair and, if necessary, alter the product.
- Making alterations to the safeguards and safety icons on the equipment is prohibited.
- The internal connections are made in the factory and are to a large extent customer-specific (refer to the supplied project drawings). Do not, therefore, alter the internal connections.
- External equipment or components that are connected to the unit, such as computers and networks, must comply with the relevant electrical isolation safety regulations.
- Both the installer/service engineer and the user must regularly check and maintain the equipment (the safeguards in particular) in accordance with the instructions in this manual. Keep the equipment clean and the surroundings tidy.
- Report malfunctions or damage to your installer immediately. Take the equipment out of operation and do not use it if a defect is found.
- Only use original spare parts for repairs (refer to the spare parts price list).
- After making repairs check the correct status and functioning of the equipment.
- If the user allows personnel to operate the equipment, he/she must adequately instruct this personnel. In particular this should cover the safety risks and safety instructions stated in this manual. He/she must also supervise correct compliance with the instructions.
- Ensure that the personal protective equipment prescribed in this manual is available and that it is used.
- Display the safety icons that are applicable in the room where the equipment is set up.

Safe handling of chemical substances



When working near or on equipment for chemical substances (such as tanks, lines and dosing channels) there is a danger of contact with concentrated fertilisers and acid or lye. These chemical substances can be caustic and corrosive, so they could cause damage to the eyes and skin and damage to equipment. The unit suctions up the liquids and mixes them with water. Once correctly mixed and at the correct pH there is almost no danger to health or safety under normal use.

Ask the supplier of the chemical substances for detailed safety information. Ensure that everyone working with or near the chemical substances is aware of the following:

- the names of the substances and the concentrations;
- the risks;
- the protective measures required;
- action to be taken in the event of contact with the skin or eyes or after inhalation or ingestion;
- action to be taken in the event of leaks.

The following safety precautions apply for working with chemical substances:

- Ensure that the tanks and lines are positioned and installed correctly in accordance with the applicable local regulations.
- Provide a facility for collecting and disposing of leaked chemical substances. Place, for example, the unit and tanks in a concrete structure that is large enough to contain the entire volume in the event of leaks.

- Set the components up in such a way that they cannot easily be damaged.
- Ensure the dilutions are correct and use materials that are resistant to chemical substances.
- Clearly mark tanks and lines with the substances they contain.
- Ensure that the room is well-ventilated.
- Wear safety glasses, safety gloves and (safety) boots that are impervious to chemical substances. Wear clean work clothes that cover as much of the skin as possible.
- Ensure that there are facilities for showering and bathing the eyes near at hand. Ensure that everyone understands where these facilities are and how to use them. Ensure that the facilities are working at all times and are clean. Regularly rinse eyewash fountains in particular to prevent bacterial pollution.
- Remove clothing immediately if it has been contaminated with chemical substances. Wash the skin and the clothing with copious amounts of water.
- Ensure that the telephone number of professional emergency services is known in case that service is required. Notify the emergency services of which substance is involved in the event of an accident.
- Ensure that facilities for collecting leaking chemical substances, cleaning them up, diluting them with water and rinsing them away are always close to hand.
- Never add water to concentrated substances – add the concentrated substance to the water! This keeps the consequences of the reactions (gas formation, heat generation, effervescence, splashing) to a minimum.
- Empty the equipment and lines and/or rinse them thoroughly with water before opening them for maintenance.
- Drain discharge water - if not reused - in accordance with the locally applicable environmental regulations.

Electrical safety



The unit is powered from the mains voltage. There is a potential hazard of electrocution or fire resulting from a short circuit. You must therefore adhere to the following safety instructions:

- Keep the housings of electrical components closed.
- Keep the electrical parts dry.
- Make sure that the earthing is connected correctly.
- Ensure that the unit is connected to its own fuse group with the correct fuses.
- The electrical connection must comply with the locally applicable regulations.

During installation, maintenance or while resolving faults it may be necessary to open the housing for the electrical components. In this case, adhere to the following safety instructions:

- Preferably, make the unit totally free of electricity by removing the plug from the socket outlet or by removing fuses from the fuse group.
- If the unit cannot be made free of electricity then take extreme care. Use well-insulated tools and do not touch the ends of wires, connections and electrical components with your bare hands. Keep the surroundings dry and ensure that there is someone close by to keep an eye on you.
- Wear an earthed wrist strap when working in the cabinet. Otherwise the electronic components may be damaged due to static electricity.

Safety with mechanical parts

Adhere to the following safety instructions to prevent injury from mechanical causes:

- Transport and position the unit in accordance with the instructions in the (installation) manual. The unit is heavy!
- Install lines in such a way that no one can trip over them. Keep the surroundings tidy and dry to prevent trips and slips.
- Keep the housing of the pump(s) closed.

Take measures to prevent water hammer to avoid damage to equipment. Fill lines gradually and bleed them before switching the pumps to full operation or fully opening main valves.

Safety with hot parts



Parts of the unit that may become hot are equipped with this sticker.

Do not touch these parts during or shortly after operation.

Noise safety



Especially the pump(s) and the filling valve produce noise when the unit is in operation. The emission sound pressure depends on the configuration selected and can rise to 85 dB(A) at the workstation (measured according to ISO 3747:2010 for a NutriFlex with a Grundfos CR64 system pump and a ditto supply pump. Given the dimensions of the unit, this emission sound pressure represents a sound power level of 99 dB(A)). Wear hearing protection, certainly for long stays in the room or if there are more noise-emitting equipments in the same room.

Safeguards

The unit has the following safeguards:

- The cabinet containing electrical components is closed with a locked door.
- The electric motors of the system pump and the supply pump (if present) are shielded by a ventilating cover.
- The motor protection switches the system pump or supply pump (if present) off if it is consuming too much current due to overloading. The process computer detects this situation and then shuts down the entire unit.
- The power supply of the modules in the cabinet is connected to a circuit breaker that removes the power if overloading occurs.
- The hot parts of the dosage valves are protected by a transparent, L-shaped plastic sheet.



Shielding on a dosage valve

- In the version with a 850 l mixing tank, there are holes in the neck of the tank to prevent the tank from coming under pressure in the event of the water supply failing to stop in time on account of a defective control float/filling valve. This is because this version has a screw cover, which cannot be lifted off the tank by excess water.



- Install and use the equipment in accordance with the instructions in this manual to ensure that the safeguards function correctly.
- Never bridge or remove the safeguards: this can lead to a serious accident.

Safety icons on the unit

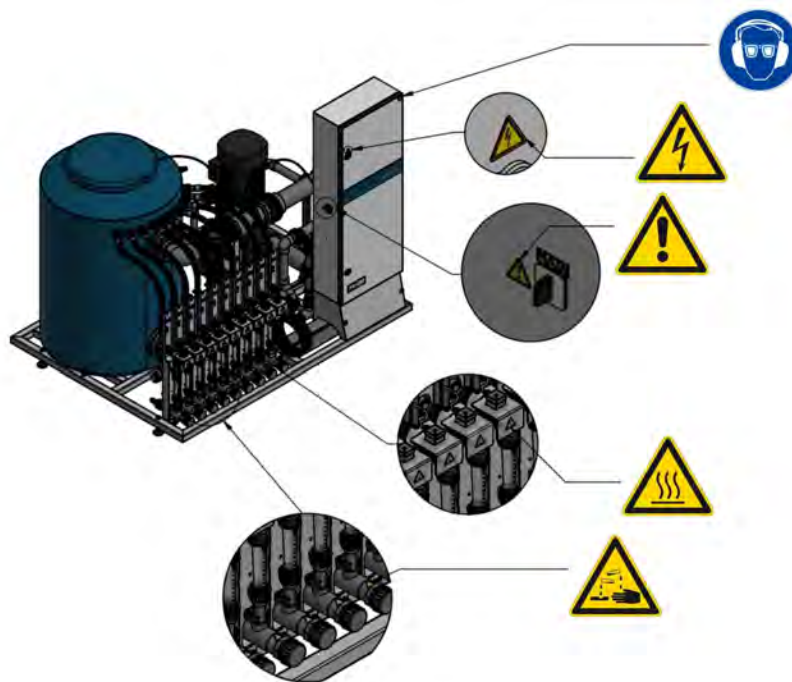

Ensure that the safety icons are clearly legible at all times. Replace any stickers with the safety icons which have become illegible.

Personal protective equipment

When working on the unit, tanks and lines always wear the following protective equipment to prevent injury or damage to your health:



Product description

Functions and intended use

The fertiliser unit provides irrigation water for horticulture. To this end, the unit has the following functions:

- preparing irrigation water;
- correcting the pH value of irrigation water;
- distributing irrigation water.

The unit can perform these functions simultaneously.

Preparing irrigation water



Only use the unit to dose diluted fertilisers for plant cultivation that are dissolved in water. The fertiliser solutions must be available in fertiliser tanks. The dilution must be such that it contains no sediment or pollution.

The unit mixes the fertilisers from the fertiliser tanks with supply water in the required ratio to form a homogeneous irrigation water with the correct EC value. This can be done according to 2 principles:

- A+B principle: fertiliser solutions are prepared (manually) in 2 (or possibly more) fertiliser tanks, in such concentrations that the unit must mix them in more or less equal amounts. In principle, the fertiliser tanks must also always be topped up at the same time. The levels may fall at different rates as a result of inaccuracies. Depending on the version, a balance level control is available to remedy this.
- ABC principle: the unit mixes the fertiliser solutions from the various fertiliser tanks in the ratios as programmed in the recipe. Whenever a fertiliser tank becomes empty this tank will have to be topped-up.

The concentration of a fertiliser solution is usually such that approximately 1 litre must be dosed per 100 litres of supply water. The capacity of the unit is determined by the capacity of the system pump, which in turn must match the capacity of the dosing channels.

Depending on the version, certain versions can mix drain water with fresh water based on the EC value (EC pre-control) or mix sources of fresh water in the desired flow rate ratios.

Correcting the pH value of irrigation water

The unit brings the pH level of the irrigation water to the desired level. One of the dosing channels has to be used to dose acid or lye for pH correction, depending on the fertilisers and the pH of the supply water.



- Nitric acid is generally used for the pH correction. In principle, phosphoric acid or sulphuric acid can also be used, but this may cause calcium phosphate or calcium sulphate sediment. Moreover, there is a greater risk of a deviating fertiliser composition, especially with phosphoric acid. Nitric acid does not have this drawback. For this reason, Priva recommends nitric acid as the acid for correcting the pH.
- Various acid channels are possible, depending on the maximum acid concentration:
 - up to 3% (weight percent), a dosing channel with rotameter is possible.
 - up to 10% (weight percent), a dosing channel without rotameter is possible.
 - up to 38% (weight percent), a dosing channel <38% acid is possible.

Distributing irrigation water

The unit distributes the irrigation water to the crop. This can be done in 2 ways:

- **Direct distribution:** the unit transports the irrigation water directly to the crop area. To do this the unit pressurises the distribution system. Then the control software opens the irrigation valves according to a specific program and controls the quantity of irrigation water. Irrigation systems, such as overhead irrigation systems, drippers and ebb and flow systems on containers and tables are possible depending on the design. In this application the unit is only active during irrigation.

The cultivation area that can be irrigated with one unit depends on the crop and the chosen combination of system pump and dosing channels.

- **Indirect distribution:** the unit supplies the irrigation water to a stock tank or silo for a period of 24 hours, for example. From there, a separate pump supplies the irrigation water to the distribution system. This pump and the irrigation valves are not controlled from the unit. With this method, in comparison with the direct method, a simpler design will be adequate with a smaller system pump while a larger crop area can be supplied with irrigation water. Complex systems with multiple stock tanks for different recipes and intelligent water management can be realised depending on the process computer that has been selected.



For critical crop conditions and large crop areas it is recommended to install a spare unit. This reduces the risk of insufficient irrigation water being available in the event of a malfunction, which could result in damage to the crop.

The irrigation water prepared in accordance with the recipe is distributed immediately. If the distribution stops - for whatever reason - the EC control and pH control automatically ensure that dosing of fertilisers and acid (or lye) also stops.

Versions

The NutriFlex is delivered as a substation. This means that the unit does not have a built-in process computer and must therefore be controlled by an external Priva process computer (Connex or Compass). This computer generally also has other tasks, such as climate control, energy management and CO₂ dosage. The Substation version does not come with a display or keyboard as standard.

You can choose: the type of supply pump (optional), the type of system pump, the type of mixing tank (300 l or 850 l), the control of the pump(s) (via magnetic switch or softstarter), the number of dosing channels and the types of dosing channels. For more details about the possibilities, see the technical specifications and the price list (for dealers).

Principle of operation

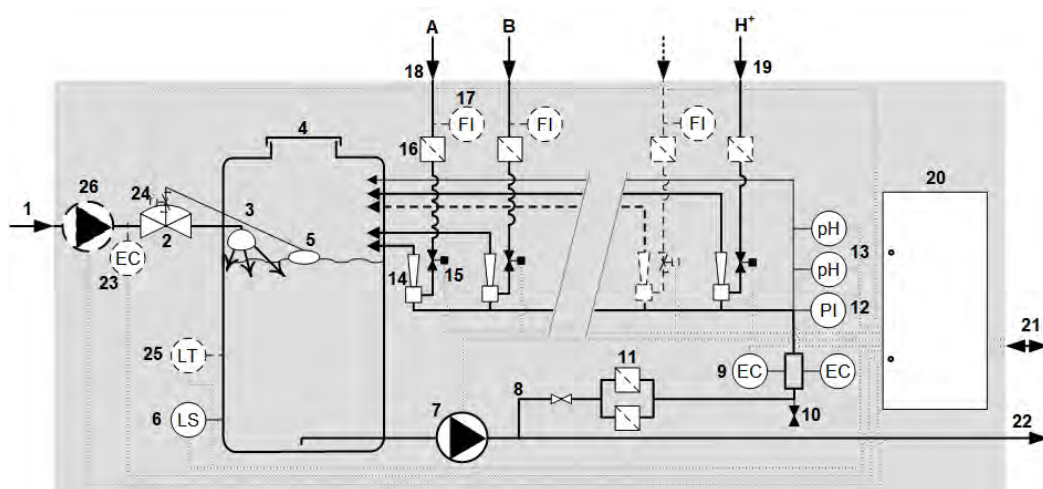

Graphic of NutriFlex fertiliser dosing unit

(The components within the grey area are supplied as standard. The components shown with a dashed line are optional. The electrical cables are drawn with a dotted line.)

Water supply and mixing tank

The supply water line (1) is connected to the filling valve (2) of the mixing tank (4). The control float (5) controls the filling valve and ensures that the mixing tank remains full. The supply water flows into the tank via the spray head (3), so that water and fertilisers are homogeneously mixed at the top of the tank.

Optionally, a supply pump (26) and an EC sensor for EC pre-control (23) can be installed on the unit.

The mixing tank is equipped with a low level switch (6) which ensures that the system pump (7) stops if the supply of water stagnates and there is a risk of the pump running dry. For the optional 'Mixing tank level reduction' process phase, a level sensor (25) and an electric valve (24) for closing the filling valve can also be installed. The 300 l mixing tank has a removable cover that does not close hermetically, so that vapours can escape and air can flow freely in and out. With capacities greater than approximately 65 m³/h, the exposure time in the tank would be too short, especially if there was a large amount of bicarbonate in the water. For such capacities, a 850 l mixing tank is therefore possible, with a screw cover and holes in the neck for bleeding.

System pump and branch with dosing channels

The system pump pumps the irrigation water from the mixing tank to the crop (22) and pumps a small amount to the branch (8). On this branch there are a hand valve, two inline dirt filters connected in parallel (11), 2 EC sensors (9), a drain point (10), a manometer (12) and 2 pH sensors (13).

The water in the branch line (drive water) flows through the venturis of the dosing channels (14). The nozzles in the venturis create a vacuum that draws in the fertilisers (18) and acid or lye (19). Dosage valves (15) are installed in the fertiliser, acid or lye lines just before the venturis. The control software pulses the dosage valves to control the open time, based on a recipe and EC and pH measurements. The time that the dosage valves are open and closed determines the flow of fertiliser, acid or lye that is dosed on average.

The branch has 5 or optionally 10 connections for dosing channels. Not all of the connections have to be used. Unused connections can be fitted with a dosing channel at a future time, if needed.

Fertiliser filters and rotameters on dosing channels

A dirt filter (16) may be installed in the fertiliser line of the dosing channel. A rotameter (17) can also be fitted, with which the fertiliser suction can be checked and, if necessary, the dosage valve can be adjusted. Rotameters are generally not used in dosing channels for acid solutions, because the acid damages the transparent tube.

Special types of dosing channels

A dosing channel for acid or lye may be identical to a dosing channel for fertilisers. When using concentrated acid or lye, however, the flow of acid or lye is (much) smaller than with fertilisers. For this reason, you can also choose a 38% acid dosing channel for acid or lye. A different type of dosage valve and other materials have been used in this.

For fertilisers and other chemical substances for which a small flow (less than 8 l/h) is required, low-volume dosing channels are available. These dosing channels also work in the same way as the other dosing channels, but are equipped with a different type of dosage valve with a specific dosing restriction, do not have a filter and are constructed from different materials.

If it has to be possible to choose between two fertiliser tanks for each dosing channel, double dosing channels may be used. These consist of two dosing channels next to each other (which also occupy two dosing channel positions) with one joint venturi, with the fertiliser tank being selected by activating either the left-hand or right-hand dosage valve. The advantage of a double dosing channel over two single dosing channels is that you only need one venturi, which reduces the purchase costs. In addition, less drive water flows through the system.

Inline dirt filter and manometer on branch

The inline dirt filters (11) in the branch prevent clogging of the venturi nozzles in the dosing channels. The dosing channels can be emptied via the drain point (10), e.g. for maintenance or if the unit will be out of service for a long time on account of a period of frost.

The manometer (12) on the branch enables a visual check of the drive water pressure.

EC and pH sensors

The electrical conductivity of the irrigation water is an indirect measure of the fertiliser concentration and is measured using EC sensors (9). The pH sensors (13) measure the pH value of the irrigation water. The pH sensors are located in a sensor holder that is connected to the branch with a thin line, so that the measurement takes place at the correct pressure and speed.

By using 2 EC sensors and 2 pH sensors, the control software can compare the measured values of the 2 sensors. If one of the two sensors is not working (correctly), the measured values will differ too greatly from each other and the control software can activate an alarm.

Cabinet

Depending on the version, the cabinet (20) contains the connections (21) for the mains power supply, valves, pumps and sensors.

Construction

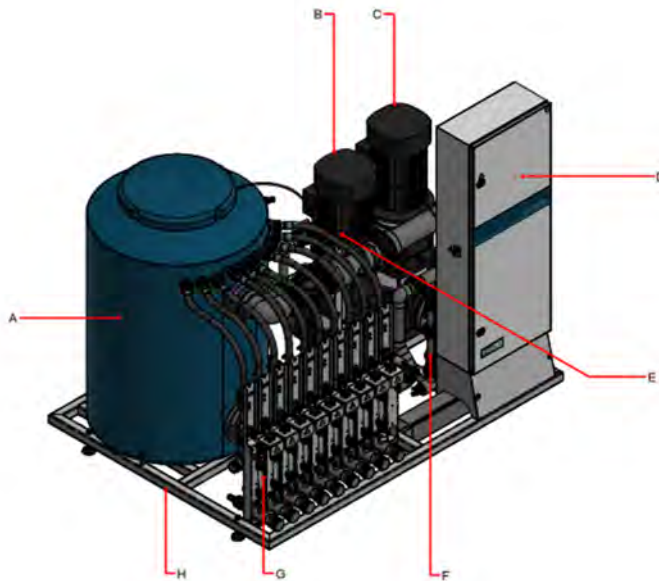

Front of NutriFlex (with 300 l mixing tank)

- A. mixing tank
- B. system pump
- C. supply pump (optional)
- D. cabinet
- E. manometer
- F. EC sensors
- G. dosing channels
- H. frame with adjustable legs

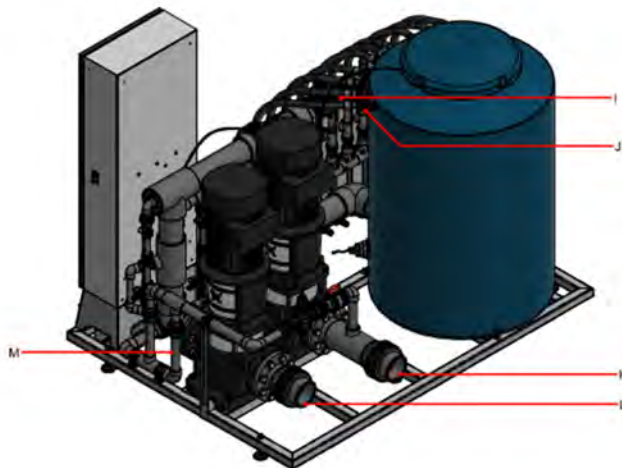

Rear of NutriFlex (with 300 l mixing tank)

- I. pH sensors
- J. filling valve
- K. line from control float
- L. connection for main irrigation line
- M. connection for supply line
- N. dirt filters



The structure of the NutriFlex 850 is comparable, but the 850 version has a black mixing tank and different dimensions.

Controls

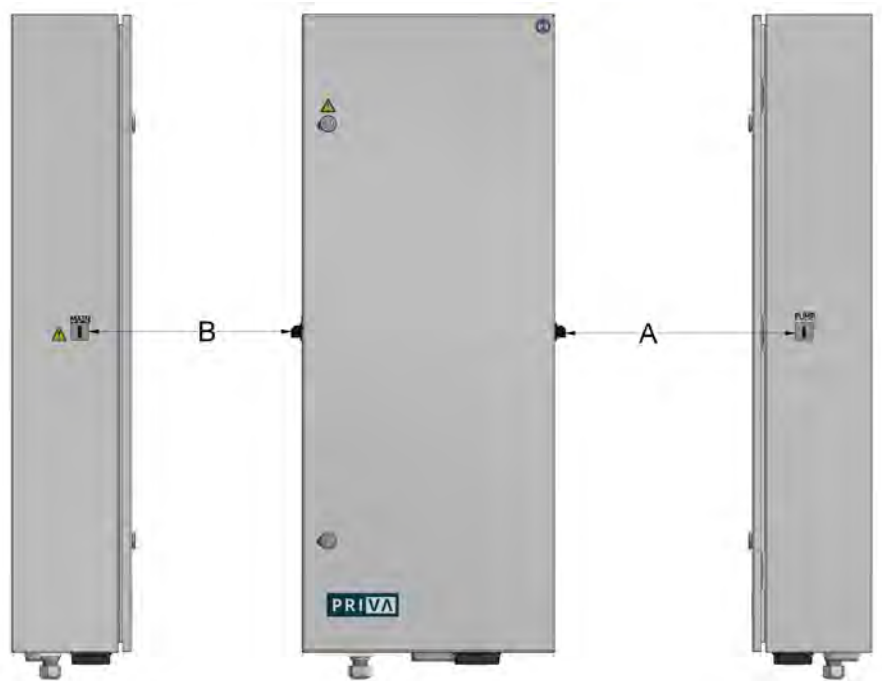

A. system pump switch ('pump switch')
B. main switch

Pump switch

The pump switch has the following positions:

- *Off*: the pump is off and cannot be switched on by the process computer
- *Manual*: the pump is on and cannot be switched off by the process computer
- *Automatic*: the pump is controlled by the process computer



The 'low level' protection in the mixing tank will be switched off when the system pump is operated manually. The pump will therefore continue to be on even when the mixing tank has been pumped dry. Therefore, switch the pump off in good time so that it does not run dry.

Main switch

The main switch has the following positions:

- *Off*: no electrical power is being supplied to the unit
- *On*: electrical power is being supplied to the unit

Workplace

After the unit has been commissioned, it works autonomously. As a result, there is no specific workplace. For maintenance, checks and alterations of setup changes (for a unit with a local operation panel) the unit must remain accessible from all sides.

Type plate on the product

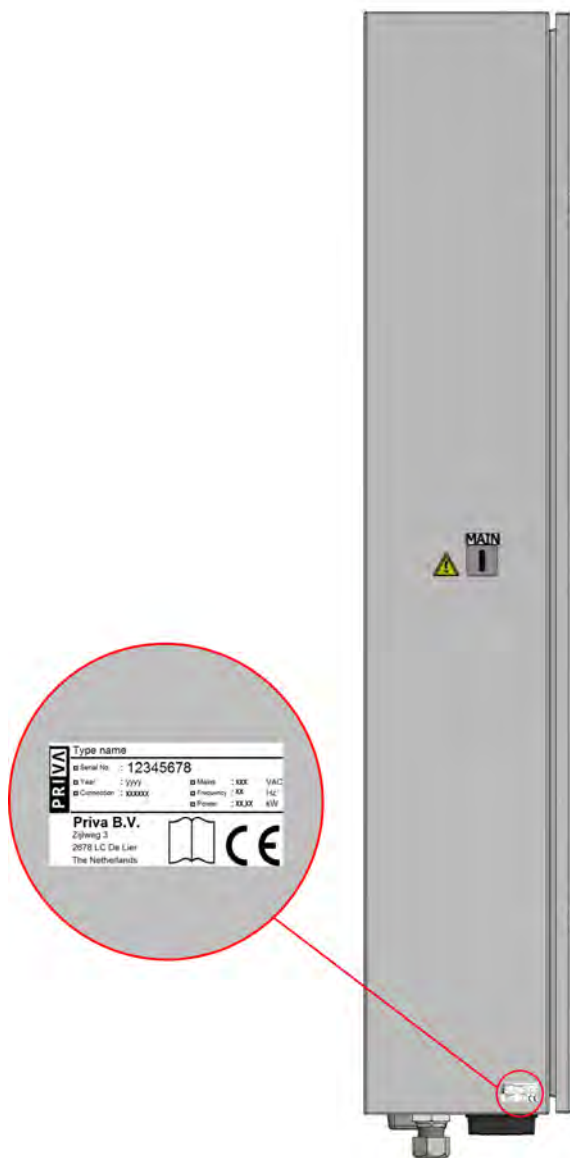

Location of the type plate

(the type plate shown here is for recognition purposes and its details may differ from the type plate on your product)

The type plate on the product contains the following information (form top to bottom and from left to right):

- Product name and type designation
- *Serial No.*: serial number
- *Year*: year of construction
- *Connection*: specification of the connections to the mains voltage
- *Mains*: required mains voltage in VAC
- *Frequency*: required mains frequency in Hz
- *Power*: nominal power consumption in kW of system pump and any supply pump
- Name, address and web address of the manufacturer (Priva B.V.)
- Manual icon
- CE mark

Warranty

The warranty expires if the product is not installed, used and maintained in accordance with the instructions in the Priva manual. For more details refer to the general terms of delivery (Priva will supply these on request and refer to www.priva.com) and the specifically agreed terms of delivery.

Transport and storage



Only Priva approved installers/service engineers who have received product-specific training from Priva are allowed to transport and store the unit.

The work to be performed by the installer for transport and storage is described in the unit's installation manual.

Installing and commissioning



Only Priva approved installers/service engineers who have received product-specific training from Priva are allowed to install and commission the unit.

The work to be performed by the installer for installing and commissioning the unit is described in the *Installation* manual for the unit concerned. This chapter only provides the information that is also relevant to users.

Location and environmental conditions

Minimum free space around unit

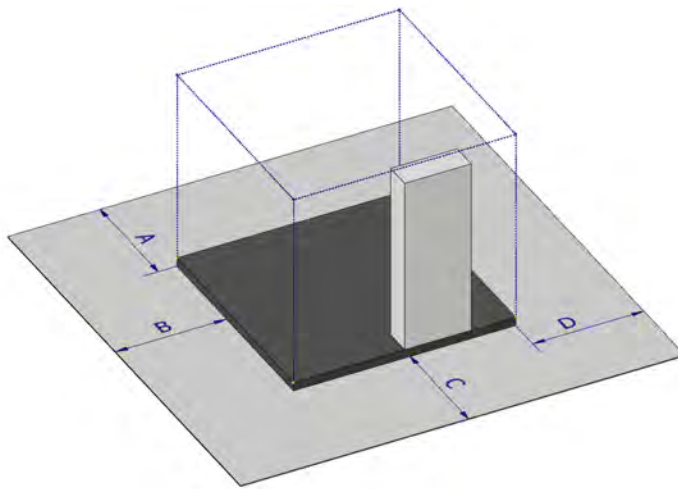

A = minimum 50 cm
B, C, D = minimum 80 cm

Environmental requirements



The unit must not be in direct sunlight. Due to bright sunlight the temperature will become too high, causing plastic parts to deform, creating malfunctions in electrical components and shortening the service life of electrical components. Always keep any cabinet ventilation grilles free and open, allowing the electrical components to be cooled.

General	Position the unit in an indoor, well-ventilated room, free from drips and splashes, with a stable temperature (no rapid temperature changes). Select a location where the unit cannot easily be damaged (e.g. by mobile equipment). The surface on which the unit will stand should be hard, flat and level.
Temperature when not operating	0 - 35°C As long as the unit contains water (residue) it must be kept frost-free.
Temperature during operation	5 - 30°C
Supply water temperature	5 - 30°C (the unit can still work at a maximum temperature of 30°C. However, with regard to the water quality and/or the operation of the unit, such a high water temperature is generally unacceptable.)
Relative air humidity	< 85% (this is lower than the maximum relative air humidity during transport because of the presence of chemical substances.) Condensation will form on the pipe-work, particularly when relatively cold supply water is used. This is very corrosive when combined with the vapours from the chemical substances. Hose clamps and other metal parts must therefore be of corrosion-resistant types of metals or must be well coated (and remain so). The cabinet contains sensitive electronic circuits and must definitely remain condensation-free.
Maximum installation height	1000 m above sea level (Cavitation may occur in the system pump when the ambient pressure is too low.)
Pollution factor (NEN-EN-IEC 61010-1)	maximum 2 (normal, non-conducting pollution)

Basic facility requirement

The installer must find the following basic facilities in the room before he positions the unit:

- a facility for capturing and discharging chemical substances in the event of leaks, for instance a concrete tank;
- connection for supply water;
- electrical connection (separately fused);
- an emergency stop feature.

Additional facilities may be required, depending on the quality of the supply water:

- Mechanical pretreatment using a filter to prevent blockages due to the sedimentation of solid particles in the system.
- Thermal conditioning using a heat exchanger if the temperature of the supply water is too low. Heating the supply water prevents condensation from spreading to the electrical components (such as the EC sensor connections). Moreover, the less cold the supply water is the more accurately the unit will dose and mix.
- Chemical pretreatment by acidification of the supply water if the water contains too much bicarbonate (see [Supply water quality \(page 46\)](#)).
- Disinfection using UV light, optionally combined with dosage of hydrogen peroxide (Priva Vialux disinfection units). This is necessary in the event of the recycling of drain water and the use of dirty surface water.

The following facilities must be also be present before the system is allowed to be filled with fertilisers:

- personal protective equipment;
- a shower (preferably a special emergency shower to rinse-off leaked chemical substances);
- an eyewash fountain;
- a fire hose to dilute and rinse away leaked chemical substances;
- safety icons on the access door(s) to the room.

Operating software

Refer to the relevant process computer software manual.

Operation



- Make sure that you understand the [Safety \(page 6\)](#) instructions before operating the unit.
- Carry out periodic maintenance in accordance with the preventative maintenance schedule (see [Maintenance and repair \(page 36\)](#)).

Process phases

The process computer recognises the following process phases (depending on the software used):

1. Rest: the pump(s) are at a standstill and the irrigation valves and flush valve are closed. The hydronic part of the system is filled with irrigation water. The process computer waits until a start condition is met.
2. Pre-purge: the system pump is running and the flush valve is open so that the contents of the main irrigation line are discharged. At the same time, the unit prepares irrigation water so that the old irrigation water in the system is replaced by new irrigation water. This phase can be gone through when changing the recipe or if the system has been idle for a long period as a result of which the quality of the irrigation water in the system is no longer clear.
3. Operation: the system pump is running and the fertiliser solution is being supplied to a stock tank (indirect distribution method) or to the valve sections (direct distribution method). In the latter case the irrigation valves are controlled open by or via the unit according to the set conditions. At the same time, the unit prepares new fertiliser solution.
4. Post-purge: the supply pump, if fitted, stops, the valves in the distribution system close (with the direct distribution method) and the dosage valves close. The system pump continues to run for 3 s to rinse the dosing channel. This prevents sediment forming in the dosing channel. After the post-purge the unit returns to the idle phase.

The pre-purge and post-purge phases can be skipped if desired.

Turning the unit on and off

The unit can be switched on and off electrically using the main switch. In principle, however, the unit must remain on constantly, unless there is a specific reason for switching the unit off. The running program can be interrupted via the operating software (see [Setting the unit to maintenance mode \(page 37\)](#)).

Emergency stop

-  It is strongly recommended that an emergency stop is provided which makes all electrical equipment in the system free of electricity simultaneously. Position the emergency stop feature close to the unit.

Pressing the emergency stop has the same result as a power supply failure.

Power supply failure

In the event of an interruption to the power supply (or when switching off, using the emergency stop for instance) the software settings and date and time are retained: the settings are saved automatically.

After the loss of power, the process computer resumes the process at the point where it stopped when the power was lost.

- 
 - Because the system pump stops prematurely during a power supply failure, the dosing channels will not be post-purged and a sediment may be formed. When the power has been restored, check therefore that the dosing channels are still functioning correctly.
 - When the power has been restored, check if there are any alarms.
 - If the power is lost for too long, you must use an alternative method to irrigate the crop.

Topping-up fertilisers and acid or lye



If the system is equipped with low level switches on the fertiliser tanks, the unit generates an alarm if the fertiliser tank is in danger of becoming empty. However, it is best not to wait for this and to top-up the fertiliser tanks early:

- If there is a single fertiliser tank for the fertiliser concerned: interrupt the program that is running (refer to [Setting the unit to maintenance mode \(page 37\)](#)).
If there are two fertiliser tanks for the fertiliser concerned: open the valve on the full fertilizer tank that has already been prepared and close the valve on the fertiliser tank that is almost empty.
- Fill the almost empty fertiliser tank with a known quantity of fresh water.
- Add a quantity of solid or concentrated fertiliser(s) or acid or lye that is appropriate to the quantity of water.
- Stir the contents of the fertiliser tank with an electric mixer until all solid matter has been dissolved and the solution is homogeneous.
- If you interrupted the program in step 1: resume the program.

- 
 - If you change the concentration of a solution in a fertiliser tank, then also adjust the recipes for that fertiliser tank. It may also be necessary to readjust the EC control (for a different concentration of fertiliser) or the pH control (for a different concentration of acid or lye).
 - If you are going to use higher concentrations, then take account of the highest concentration to which the equipment is resistant. This applies above all to the acid channel.

Adjusting the user settings

There is a large number of possible settings depending on the model, configuration and crop that have been selected. The software manual for the process computer concerned contains a comprehensive description of all possible user settings. Broadly speaking, it is a matter of:

- division of the irrigation valves and their linking to the start programs;
- recipes for the various irrigation valves (which fertiliser tanks are to be used for dosing and in what ratio, the EC value and pH value and the quantity of irrigation water per irrigation cycle);
- start programs (criteria for starting and stopping the irrigation cycle).

Operation is described in the software manual for the relevant process computer (Connex or Compass) and depends on the software version used. See chapter *Procedures > Operating the dosing unit*.



Make (or arrange to be made) a back-up of all settings before adjusting them.



The EC value and the concentration of fertilisers are directly related to each other. The EC value has nothing to do with the nature and mixing ratio of the fertilisers however. The recipe indicates which fertilisers should be dosed in what ratio. The EC setting determines the quantity of fertiliser to be dosed in total. If you use supply water with an EC value that is too high it is possible that no fertilisers or a very small quantity of fertilisers will be dosed.

Parts

pH sensor

Fitting the pH sensor



Fitting the pH sensor



Follow the procedure below without break so that the pH sensors remain wet.

1. Remove the pH sensor from the packaging containing storage liquid.
2. Remove ring (A, if present) from the pH sensor.
3. Slide the O-ring (B) of the holder over the pH sensor.
4. Assemble parts C, D and E in the order shown in the figure. Ensure that the bevel on C is at the bottom.



Pour water into the holder if it is still dry.

5. Connect the pH sensor to the PCB for pH sensors in the cabinet.
6. Calibrate the pH measurement (refer to [Calibrating the pH measurement \(page 26\)](#)).
7. Screw the pH sensor onto the pH sensor holder.

Calibrating the pH measurement

Calibration is described in the software manual of the relevant process computer (Connex or Compass) and depends on the software version used. See chapter *Procedures > Maintaining, checking and calibrating*.

Cleaning the pH sensors



pH sensor holder and pH sensor

The pH sensors have to be unscrewed from the pH sensor holder for cleaning. Only do this when the unit is in maintenance mode (software-wise and pump switch(es) off). Check the screw coupling on the pH sensor holder for leaks after putting back into operation.

-  In principle, the sensor cables in the cabinet can remain connected during maintenance. However, the sensor cables must be disconnected if the current situation requires this so that cleaning can take place elsewhere.

Cleaning the pH sensor normally

1. Clean the glass membrane and the housing of the sensor with a solution of liquid detergent in warm water. Use a soft brush or a clean cloth, dipped in the soap solution. Do not use a paper towel.

 Do not apply excessive pressure to the glass membrane as it is fragile.

2. Rinse the glass membrane well with distilled water. Then immerse the sensor for at least 30 minutes in a 50/50 mixture of pH 4 buffer and 4M KCl before using it again.

-  It is advisable to recalibrate the pH measurement after cleaning.

Cleaning the pH sensor thoroughly



If there is an anorganic deposit on the pH sensor then remove it as follows:

1. Make a homogeneous acid dilution of:
 - approximately 1 part drinking water and 1 part concentrated nitric acid (38% (by weight))
 - or
 - 4 parts drinking water and 1 part concentrated phosphoric acid (59% (by weight)).

 Add the acid to the water; never add water to acid.

2. Immerse the glass membrane of the pH sensor in the acid solution for 5 minutes (no longer!).
3. Rinse the pH sensor with drinking water, and rinse the glass membrane with distilled water. Next, calibrate the pH measurement.

- Dispose of the acid dilution in accordance with the locally applicable regulations.

Technical specifications - pH sensor

Article description	pH sensor (max. 10.0 bar)
Article number	3779046
Housing	glass
Length of sensor	77 mm
Diameter of sensor	Ø 12 mm (Ø 15 mm with protective cover)
Measurement principle	pH electrode for H ⁺ ions
Discrimination	59 mV/pH (in operating range 4 .. 7 pH at 25 °C)
Operating range (measured values satisfy the specified accuracy)	4 .. 7 pH
Range (sensor produces measured values)	3 .. 14 pH
Accuracy (after calibration)	± 0.1 pH (in operating range 4 .. 7 pH at 5 .. 30 °C)
Cable	coax, Ø 2.5 mm, length 3 m
Connector	BNC

Inline dirt filter

Cleaning the inline dirt filter



Inline dirt filter



If a manometer is installed in the distribution line, you can compare the pressure in the distribution line with the pressure in the line to the venturi's. A significant pressure difference indicates contamination of the dirt filter.

- Set the unit to maintenance mode (software-wise and pump switch(es) to 0 (off).
- Loosen the coupling and remove the filter element from the housing.
- Rinse the filter element underneath the tap until clean.
- Replace the filter element and tighten the filter element.
- Put the unit back into operation.

Filter of dosing channel

Cleaning the dosing channel filter



Dirt filter of dosing channel

1. Set the unit to maintenance mode (software-wise and pump switch(es) off).
2. Close the valve on the fertiliser line concerned. If there are valves at the start and end of the fertiliser line then close the valve at the end (closest to the unit).
3. Place a plastic receptacle underneath the filter.
4. Unscrew the cap from the filter and remove the filter element from the filter housing.
5. Rinse the filter element underneath the tap until clean.
6. Replace the filter element and screw the cap back onto the filter.
7. Open the valve on the fertiliser line concerned.
8. Check that the filter is not leaking.
9. Empty the receptacle into the appropriate tank of fertiliser.
10. Put the unit back into operation.

Flow sensor



Cleaning the flow sensor

1. Set the unit to maintenance mode (software-wise and pump switch(es) off).
2. Make sure the main irrigation line is pressure-less and, if necessary, empty.
3. Unscrew the flow sensor from the T-piece.
4. Clean the paddle wheel of the flow sensor using a small, soft brush.
5. Apply a little acid-free grease to the rubber O-rings to prevent them from being damaged when placing the sensor back.
6. Screw the flow sensor back onto the T-piece: you can only do this one way.
7. Fill and bleed the main irrigation line to prevent water hammer.
8. Check that the flow sensor coupling is not leaking.

Taking out of operation



Take the unit (and the rest of the system) out of operation for longer periods – such as winter – as follows:

1. Take the planned taking out of operation into account in your stock planning. Use up the stock to the extent possible.
2. Operate the unit manually to suction and – diluted with supply water – blow off the last remnants from the tank.
3. Spray the inside of the fertiliser tanks clean using water. Operate the unit manually to suction the rinse water out of the fertiliser tanks and in doing so rinse the lines, filters and the unit.



The 'low level' protection in the mixing tank will be switched off when the pump is operated manually. The pump will therefore continue to be on even when the mixing tank has been pumped dry. Therefore, switch the pump off in good time so that it does not run dry.

4. Stop the supply of supply water and blow off the contents of the mixing tank until the minimum level is reached. Then set the pump switch to off.



Leave the unit on: switching off leads to alarm messages and possible faults from the process computer.

5. Drain the branch line to the venturis by opening the drain valve below the EC sensors.
6. Clean the filters.
7. Clean the EC sensors.
8. Clean the pH sensors (if fitted) and place them in the storage liquid.
9. Clean the flow sensor (if fitted).
10. If there is a risk of freezing, drain the water supply system and the water distribution system.
11. If there is a risk of freezing in the room where the unit is set up:
 1. Drain the system pump (if fitted) and the supply pump (refer to the manuals for the pumps concerned).
 2. Remove the remaining water by unscrewing the lines on the unit or suctioning-off the water.
 3. Disconnect the pH sensors in the cabinet and store them with the glass membrane in storage liquid in a frost-free location.
12. Preferably, cover the unit with a tarpaulin.

Taking back into operation is, in principle, the same as the first commissioning. However, certain actions, such as configuring the I/Os, can be skipped.

Troubleshooting



Certain activities may only be performed by authorised installers/service engineers because they require specialist knowledge and skills. These activities are indicated by "Installer" in the table below.

Problem	Possible cause	Solution(s)
The unit does nothing	The electrical supply is off.	<ul style="list-style-type: none"> Ensure that the unit is connected and the main switch is on. Ensure that the external emergency stop (if fitted) is not depressed. Ensure that the fuse group to which the unit is connected is switched on. Installer: reset the circuit breaker in the cabinet.
	The power supply to the unit is defective.	<ul style="list-style-type: none"> Installer: check the internal fuses. Installer: replace the power supply.
	An internal circuit is defective.	Installer: determine which circuit is defective and replace it.
The system pump does not start	The pump switch is off.	Ensure that the pump switch is set to automatic.
	The motor protection has been triggered.	Installer: reset the motor protection in the cabinet
	An alarm has been activated.	Check which alarm is involved and take action accordingly.
	There is a defect in the circuit that controls the pump motor.	Installer: determine what is defective and replace the defective components.
The system pump runs dry.	The low level switch in the mixing tank is defective.	Installer: check the low level switch and replace if necessary. In addition, check that the pump has not been damaged by running dry.
Supply water is not entering the mixing tank.	There is no supply water.	<ul style="list-style-type: none"> Installer: check the supply pump (if fitted). Installer: check the supply valve (if fitted). Ensure that the filter in the supply line is clean.
	The control float is defective.	Installer: check if water is flowing to the control float via the control line. Replace the control float if necessary.
	The filling valve is defective.	Installer: replace the filling valve.
The mixing tank overflows.	The control float is not correctly adjusted.	Installer: readjust the control float.
	The control line (of the control float) is leaking.	Installer: replace the control line.
	The filling valve is leaking or is defective.	Installer: replace the filling valve.
	The non-return valve in the main irrigation line is not functioning correctly.	Installer: clean the non-return valve. Replace the valve if this does not resolve the problem.
While preparing irrigation water the manometer on the pipe-work to the venturis indicates a pressure that is too low.	The discharge valve is open or there is a (major) leak in the distribution system.	<ul style="list-style-type: none"> Ensure that the discharge valve is closed. Installer: check the distribution system for leaks, and repair them if necessary.
	The system pump is turning in the wrong direction.	Installer: swap 2 phases of the mains power supply (disconnect electrical power first!)
	There is air in the system pump.	Bleed the system pump (refer to the documentation for the pump concerned).
	The dirt filter on the unit is blocked.	Clean the dirt filter.

Problem	Possible cause	Solution(s)
A fertiliser (or acid or lye) is not being dosed.	The level in the fertiliser tank is too low, causing air to be drawn in.	Ensure an adequate level in the fertiliser tank. Then ensure that the air is bled from the fertiliser line.
	A valve in the fertiliser line (if fitted) is closed.	Check whether the valve or valves in the fertiliser line are open.
	There is an air bubble in the fertiliser line.	Ensure that the air bubble is bled from the line.
	The dosage valve does not open.	<ul style="list-style-type: none"> Check the software settings (for instance whether the fertiliser is included in the recipe). Installer: check the circuit that controls the dosage valve. Replace any defective components. Installer: Check the dosage valve. Replace it if necessary.
	There is no flow, or an insufficient flow, of water through the venturi.	Installer: check if the same applies to all venturis (by looking under the lid of the mixing tank). If the flow rates are equally low from all venturis, then check the pressure shown by the manometer on the pipe-work to the venturis. If only the flow rate from the venturi concerned is too low, the nozzle of this venturi may be blocked.
	A filter in the fertiliser line is blocked.	Clean the filter.
The desired EC value is not being achieved.	There is a leak in the fertiliser line or in the connection between the dosage valve and the venturi allowing air to be suctioned-in.	Installer: check the pipe-work for leaks.
	The desired value is higher than the value that can be achieved with the fertiliser solutions.	<ul style="list-style-type: none"> Correct the set value. Increase the concentration of the fertiliser solutions.
	The EC value of the nutrient recipe has been incorrectly set.	Prepare the irrigation water manually according to the quantities in the nutrient recipe and measure the EC value of the mixture. Enter this value as the EC value for the nutrient recipe.
	The set value and the nutrient recipe are correct, but the concentration of one or more fertiliser solutions is too low.	Ensure that the concentrations of the fertiliser solutions are correct.
	The set value is correct, but is lower than the EC value of the supply water.	Increase the quantity of fresh water compared to drain water (if applicable).
	A fertiliser is not being dosed.	See the solutions for the problem 'A fertiliser (or acid or lye) is not being dosed'.
	The EC sensors are dirty.	Installer: clean the EC sensors.
The EC value swings wildly and "overshoots".	The P/I-factors of the EC control are set to a value that is too low.	Installer: reset the P/I-factors.
	The set value of the nutrient recipe EC is incorrect.	Installer: correct the nutrient recipe EC.

Problem	Possible cause	Solution(s)
The desired pH value is not being achieved.	The desired value is unattainable.	<ul style="list-style-type: none"> Correct the set value. Check if an incorrect tank has been connected, which is causing lye to be mistakenly dosed instead of acid or acid instead of lye. Check in the software if lye is mistakenly being dosed instead of acid or acid instead of lye. Increase the concentration of the acid or lye.
	The nutrient recipe has been set incorrectly.	Adjust the quantity of acid or lye in the nutrient recipe, taking into account the quantity of bicarbonate in the supply water.
	The set value and the nutrient recipe are correct, but the concentration of the acid or lye solution is too low.	<ul style="list-style-type: none"> Check if lye is mistakenly being dosed instead of acid or acid instead of lye. Ensure that the concentration of the acid or lye solution is correct.
	The acid or lye is not being dosed.	See the solutions for the problem 'A fertiliser (or acid or lye) is not being dosed'.
	The pH sensors are dirty or worn out.	<ul style="list-style-type: none"> Clean the pH sensors. Installer: replace the pH sensors if cleaning does not resolve the problem.
	The P/I-factors of the pH control are set to a value that is too low.	Installer: reset the P/I-factors.
The pH value swings wildly and "overshoots".	The concentration of acid or lye in the acid or lye tank is too high.	Reduce the concentration in the acid or lye tank.
	The quantity of acid or lye in the recipe is set too high.	Reduce the quantity of acid or lye in the recipe.
	The supply water contains too little bicarbonate.	<ul style="list-style-type: none"> Installer: install a pre-treatment system for the supply water (see Supply water quality (page 46)). Install a flow rate ratio control to mix the supply water with another water source that contains the correct amount of bicarbonate.
	The P/I-factors of the pH control are set to a value that is too high.	Installer: reset the P/I-factors.
	At least one of the pH sensors is not functioning (correctly).	Calibrate the pH measurement.
EC alarm or pH alarm	The alarm threshold has been set incorrectly.	Correct the alarm threshold setting.
	At least one of the two sensors is dirty or defective.	<ul style="list-style-type: none"> Installer: check the sensors. Clean the pH sensors (if necessary) and perform a new calibration. Installer: clean the EC sensors (if necessary) and perform a new calibration. Installer: replace the suspect sensor(s) if this does not resolve the problem. <p>A measuring case with a reference pH meter and a reference EC-meter (the meters are also available separately) is available for checking pH sensors and EC sensors and for measurements outside of the unit. Calibration liquids and storage liquids are available separately.</p>
Flow alarm	The alarm threshold has been set incorrectly.	Correct the alarm threshold setting.
	The flow sensor (if fitted) is not set correctly.	Installer: check the flow sensor settings.
	The flow sensor is dirty or defective.	<ul style="list-style-type: none"> Clean the flow sensor. Installer: replace the flow sensor if cleaning does not resolve the problem.
	There is a leak in the main irrigation line or in a valve section.	Installer: trace the leak and fix it.
The plants receive more water than the set amount.	The flow sensor (if fitted) is dirty or defective.	<ul style="list-style-type: none"> Clean the flow sensor. Installer: replace the flow sensor if cleaning does not resolve the problem.

Problem	Possible cause	Solution(s)
Some irrigation valves no longer open.	The fuse of the relevant fuse group on the I/O board has burned out.	Installer: replace the defective fuse.
Analysis shows that the fertiliser concentrations do not match the recipe.	The dosage valves are supplying a flow rate that differs from that expected by the software.	Installer: readjust the dosage valve(s).

Maintenance and repair



- Carry out periodic maintenance in accordance with the preventative maintenance schedule.
- Some maintenance activities may only be performed by authorised Priva installers/service engineers who have received product-specific training from Priva. This is indicated in the preventative maintenance schedule.
- Switch the unit off using the main switch before carrying out any maintenance work. If the unit has to remain on within the scope of the maintenance work take extra care.
- Only use original Priva spare parts.

Preventative maintenance schedule

Minimum frequency	Action	To be carried out by	Explanation
always	be on the alert for leaks and abnormal noises (from the pump(s))	user	
weekly	check quantity of irrigation water to plants	user	1. For each irrigation valve, place a number of drippers in plastic beakers. 2. After the irrigation cycle, add the content of the beakers to a measuring beaker and read the volume. 3. Divide this volume by the number of beakers to determine the average volume per dripper.
	keep the unit and surrounding area clean	user	See Cleaning the exterior of the unit (page 37) .
monthly	clean dirt filters and other filters	user	See Cleaning the inline dirt filter (page 28) and Cleaning the dosing channel filter (page 29) .
	check system pump pressure (via manometer on pipe-work to venturis)	user	Test with system pump running and normal consumption of irrigation water. See the pump documentation for the correct pressure.
	check pH sensors	user	See pH sensor (page 26)
annually	flow sensor	user	See Cleaning the flow sensor (page 30)
	check EC sensors	installer / service engineer	
	clean rotameters on the dosing channels	installer / service engineer	
	check the operation of the dosing channels	installer / service engineer	
	check low level switch in mixing tank	installer / service engineer	
	check control float in mixing tank	installer / service engineer	
	check filling valve	installer / service engineer	
depending on the sensor	maintain other sensors that are connected to the unit (such as a light sensor)	depending on the sensor	Refer to the documentation for the sensor concerned.

Setting the unit to maintenance mode

Levels of setting to maintenance mode

The unit has be taken out of operation for maintenance. This can be done at three levels, depending on the nature of the maintenance:

1. Take the unit out of operation software-wise: this is necessary for maintenance where the software plays a role, such as calibrating sensors.
2. Take the system pump (and supply pump, if present) out of operation by switching off the pump switch(es): this is necessary for maintenance where the pumps absolutely must not start operating, such as when cleaning the dirt filter or calibrating the pH measurement.
3. Switch off the unit by setting the main switch to off: this is necessary for maintenance where the cabinet has to be open or where electrical parts may become wet, such as replacing electrical components and cleaning the exterior.



Please note that switching off the unit leads to alarm messages and possible malfunctions of the external process computer.

Set the unit to maintenance mode in ascending levels, not only the level concerned. For example, for level 2, first perform level 1 and then level 2.

Cleaning the exterior of the unit

1. Turn off the main switch of the unit.
2. Clean the exterior of the unit:
 - Remove dust using a soft brush.
 - Wipe-down the surfaces with a damp cloth.



- Do not use aggressive or abrasive cleaners: they may damage the plastic. Use warm water only, with a few drops of washing-up liquid if necessary.
- Make sure that no water runs into the electrical components. For example, do not spray water onto the unit and thoroughly wring out the cleaning cloth before use.
- Do not press too hard on the operating panel / display and the keyboard (if fitted) when removing dirt.

3. Put the unit back into operation.

Disposal of waste equipment

The installer must dispose of the unit at the end of its service life. The procedure for this is described in the *Installation* manual for the unit concerned.



The equipment is marked in accordance with European directive 2002/96/EC relating to waste electrical and electronic equipment (WEEE):



The mark indicates that the equipment cannot be disposed of with other household waste at the end of its service life. To prevent possible harm to the environment or to human health from uncontrolled waste disposal the equipment must be kept separate from other types of waste and be recycled in a responsible manner, so that the sustainable reuse of material sources is stimulated.

Appendices

EC Declaration of Conformity



The manufacturer:

Name of manufacturer Priva B.V.
 Manufacturer's address Zijlweg 3
 2679 LC De Lier
 P.O. Box 18
 2679 ZG De Lier
 The Netherlands

declares the product:

Product name NutriFlex
 Model/type Substation
 Function Fertiliser dosing unit for the horticulture industry

is in conformity with the following European Directives:

- Low Voltage Directive 2014/35/EU

and conforms to the following harmonised European standards:

NEN-EN-IEC 61010-1:2014	Safety requirements for electrical equipment for measurement, control, and laboratory use - Part 1: General requirements
NEN-EN-IEC 62368-1	Audio/video, information and communication technology equipment - Part 1: Safety requirements

The technical file was compiled by the R&D department of Priva B.V.

The Netherlands, De Lier, February 2012

M. Prins
 Managing Director

Technical specifications

Technical specifications - general

	NutriFlex with 300 l mixing tank	NutriFlex with 850 l mixing tank ¹⁾
Article number	depending on version, see price list (for dealers)	
Principle of operation	open mixing tank	
Fertiliser mixing principles	A + B principle (equal quantities of fertilisers) ABC-principle (adjustable ratio of fertiliser quantities)	
Irrigation capacity	5 – 65 m ³ /h net (depending on the selected system pump) 0.5 – 6.5 ha with direct irrigation (depending on the selected system pump)	65 – 110 m ³ /h net (depending on the selected system pump) 6.5 – 11 ha with direct irrigation (depending on the selected system pump)
Possible types of dosing channels	<ul style="list-style-type: none"> • 300 l/h dosing channel (with dirt filter and without rotameter, or with dirt filter and rotameter) • 600 l/h dosing channel (with dirt filter and without rotameter, or with dirt filter and rotameter) • double dosing channel (with dirt filters and without rotameters, or with dirt filters and rotameters, occupies 2 adjacent positions for dosing channels) • 38% acid dosing channel (50 l/h) <p>As a custom solution:</p> <ul style="list-style-type: none"> • 100 l/h dosing channel (with dirt filter and without rotameter, or with dirt filter and rotameter) • low volume dosing channel (2 or 8 l/h) • triple dosing channels 	<ul style="list-style-type: none"> • 600 l/h dosing channel (with dirt filter and without rotameter, or with dirt filter and rotameter) • double dosing channel (with dirt filters and without rotameters, or with dirt filters and rotameters, occupies 2 adjacent positions for dosing channels) • 38% acid dosing channel (50 l/h) <p>As a custom solution:</p> <ul style="list-style-type: none"> • 100 l/h dosing channel (with dirt filter and without rotameter, or with dirt filter and rotameter) • low volume dosing channel (2 or 8 l/h) • triple dosing channels
Maximum number of dosing channels	9 for fertilisers and 1 for acid or lye	
Volume of mixing tank	300 l gross / 270 l net	850 l gross / 750 l net
Permissible supply water pressure	2 – 4 bar	
Pumps	In the calculation of the installation, the system pump and optional supply pump are selected on the basis of various criteria. Pumps are available with various capacities and for various mains voltages and mains frequencies. ²⁾	
System pump protection	<ul style="list-style-type: none"> • dry running protection based on low level switch in the mixing tank • overload protection based on motor protection 	
Supply pump protection (if fitted)	overload protection based on motor protection (no dry running protection)	
Manometer for visual pressure check	checking of drive water pressure on venturis (pressure side of system pump)	
Regulations and standards with which the unit complies	see the EC Declaration of Conformity	

¹⁾Capacities greater than approximately 75 m³/h require a custom solution.

²⁾In order to make a choice, dealers can consult the specifications in the price list. The configuration ultimately supplied and the associated most relevant specifications are summarised in the test report (“Product Delivery” form) that is supplied with the unit. The manuals of the selected components are also supplied with the unit.

Technical specifications - mechanical

	NutriFlex with 300 l mixing tank	NutriFlex with 850 l mixing tank
Dimensions	see figure Dimensions of NutriFlex (with 300 l mixing tank) (page 42)	
Dimensions in packaging (L x W x H)	183 x 137 x 165 cm	227 x 172 x 195 cm
Mass (lowest mass with lightest system pump and without supply pump, highest mass with heaviest system pump and heaviest supply pump)	400 – 620 kg	approx. 570 kg
Materials which (may) come into contact with chemical substances	<ul style="list-style-type: none"> • PE: mixing tank • PVC: lines and screw couplings • PP: dirt filters of dosing channels • PA-12: tube of rotameter¹⁾ • fluoropolymers: PVDF, PTFE and FPM for 38% acid dosing channel¹⁾ and PTFE for float body of rotameter¹⁾ • NBR: O-rings of rotameters¹⁾ and filters of dosing channels • EPDM: membranes and seals of dosage valves • Stainless steel: frame, pumps and fixing equipment, AISI316 for housings of dosage valves and AISI329 for float body of rotameter¹⁾ • powder coated steel: pumps and cabinet 	

¹⁾If present.

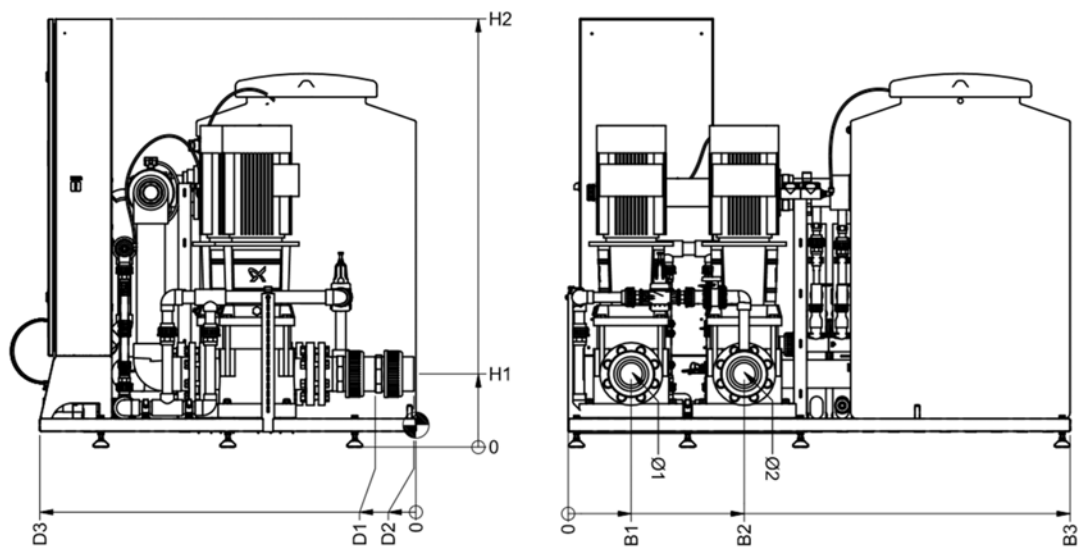

Dimensions of NutriFlex (with 300 l mixing tank)

Sys. pump ¹⁾	Supply pump	Ø1 (mm) ²⁾	Ø2 (mm) ²⁾	B1 (mm)	B2 (mm)	B3 (mm)	D1 (mm)	D2 (mm)	D3 (mm)	H1 (mm) ³⁾	H2 (mm) ⁴⁾
NutriFlex with 300 l mixing tank											
CR15	CR15	63	63	200	560	1600	259	108	1200	184	1366
CR15	-	63	63	200	560	1600	122	108	1200	145	1366
CR20	CR20	63	63	200	560	1600	259	108	1200	184	1366
CR20	-	63	63	200	560	1600	122	108	1200	145	1366
CR32	CR32	75	75	200	560	1600	207	29	1200	199	1366
CR32	-	75	75	200	560	1600	132	29	1200	151	1366
CR45	CR45	90	90	200	560	1600	124	10	1200	234	1366
CR45	-	90	90	200	560	1600	149	10	1200	159	1366
CR64	CR64	110	110	200	560	1600	80	2	1200	234	1366
CR64	-	110	110	200	560	1600	225	2	1200	209	1366
NutriFlex with 850 l mixing tank											
CR64	CR64	110	110	200	920	2070	362	244	1500	234	1500
CR64	-	110	110	200	920	2070	244	244	1500	209	1500
CR90	CR90	110	110	200	920	2070	377	259	1500	234	1500
CR90	-	110	110	200	920	2070	259	259	1500	209	1500

¹⁾Not all the pumps in this table are included in the price list. They are, however, available on request.

²⁾Various metric and imperial adaptation rings are available for the screw coupling to connect to pipes of various diameters and pipes with screw thread.

³⁾In the event of a custom solution, depends on the system pump.

⁴⁾Depends on the adjustable legs of the frame.

Technical specifications - electrical

NutriFlex	
Required mains voltage and mains frequency	The mains voltage and mains frequency must be specified on ordering. The following options are available: <ul style="list-style-type: none"> • 200 VAC +/-10% • 400 VAC +/-10% • 440 VAC +/-10% • 460 VAC +/-10% • 480 VAC +/-10% with a mains frequency of 50 or 60Hz.
Maximum power consumption	300 VA excluding system pump and any supply pump. The electrical power consumed by the pump(s) is, however, much greater (see specifications of pump(s)).

Technical specifications - process computer

The process computer is described in detail in the hardware and software manuals of the relevant process computer. The table below only provides a summary of the aspects that are important for the fertiliser dosing unit.

	NutriFlex with Connex	NutriFlex with Compass
Process computer	external: Connex fertiliser dosing unit is a substation in the network of the process computer	external: Compass fertiliser dosing unit is connected to the I/Os of the process computer
Operation	remotely via external process computer	remotely via external process computer
Program cycle	day or week (other options depending on configuration, see software manual)	week with number of starts per day (see software manual for other options)
Number of valve groups or valves to be started independently of each other ¹⁾	equal to the number of set start programs	equal to the number of set start programs

	NutriFlex with Connex	NutriFlex with Compass
Number of periods per 24-hour period in which a start for a valve group or valve ¹⁾ can be defined	6	4
Start based on ²⁾	among other things time, temperature, radiation level, radiation sum, external control (for instance level in a tank) and manually (see software manual for all options)	among other things time, radiation level, radiation sum, external control (for instance level in a tank) and manually (see software manual for all options)
Stop based on ²⁾	duration, quantity of irrigation water, external control (for instance level in a tank), manual and malfunction or alarm	duration, quantity of irrigation water, external control (for instance level in a tank), manual and malfunction or alarm
Number of recipes (a recipe includes, among other things, the settings for the desired EC and pH values)	depending on the selected configuration (see software manual)	8
Selection of fertiliser tank (tanks A1, B1, C1 etc. or tanks A2, B2, C2 etc.) ²⁾	yes	no (if the option for selecting a supply water source is not applied, that option can be used with a small adjustment of the internal wiring for the selection of fertiliser tanks)
Mixing tank level reduction	yes	no
Balance level control (with A+B principle) ²⁾	yes	no
Selection of supply water tanks or day storage tanks ²⁾	yes	yes, maximum of 8 tanks
Irrigation water flow rate or volume measurement ²⁾	yes	yes
Dosage can anticipate a change in irrigation water flow ('feed forward' control)	yes	no (there is a reaction to the change via 'feedback' control, but it is slower than via 'feed forward' control)
Control may take account of the number of irrigation valves that are open at the same time	yes	no
Drain measurement ²⁾	yes, both volume and EC (and pH) of several drain measurements The actual moment of starting (after the start program has been launched) can be influenced based on the drain quantity.	no
Supply water from different sources can be mixed on the basis of EC or flow ratio ²⁾	yes	no
EC correction based on light intensity ²⁾ (lower EC value if there is a lot of sun and a large amount of evaporation)	yes	no
Flush valve can be controlled automatically during a recipe change	yes	no
Backwashing program for sand filter ²⁾	yes, up to 8 filters switched in parallel	yes, 1 filter
Registration of the measured values and settings	yes, with extensive reporting capabilities via Priva Office Direct (depending on selected configuration, see software manual)	yes, but without extensive reporting capabilities
Alarm functions and warning signal	various options (see software manual)	various options (see software manual)
Printer connection (for printing alarms and reports)	on process computer, not on the unit	on process computer, not on the unit
Available languages for software operation	see price list	see price list

¹⁾In the Connex software, valve groups are linked to start programs, in the Compass software valves are linked to start programs.

²⁾To make use of these options, sensors and other components (such as I/O expansions) that are not supplied as standard may be required.

Technical specifications - pumps

- The mains voltage and mains frequency must be specified on ordering.
- The table presents the commonly used mains voltage (380 - 415 VAC/3 phases, neutral and earth).

Pumps for other mains voltages, with different nominal flows and other lift heights, or with an integrated pressure control, are available on request, e.g.:

- 220 – 240 VAC/50 Hz/3 phases and earth without neutral
- 208 – 230 VAC/60 Hz/3 phases and earth without neutral
- 440 – 480 VAC/60 Hz/3 phases and earth without neutral
- 346 – 380 VAC/60 Hz/3 phases and earth without neutral
- More technical specifications for the pumps can be found in the supplied pump manual.



The article numbers shown in the table below apply to a complete pump set, including control circuit (magnetic switch for pump < 4 kW and softstarter for pump > 4 kW).

Pump specifications

Article number	Type of pump	Usage	Mains frequency and voltage	Power consumption of pump (kW)	Nominal ¹⁾ flow (m ³ /h)	Lift height (m water column) at nominal ¹⁾ flow	
8871	CR15-2	supply pump	50 Hz 3x 380 – 415 VAC (3 phases, neutral and earth)	2.2	17	22	
8811	CR15-3	system pump		3.0	17	33	
8812	CR15-4			4.0	17	44	
8873	CR20-2	supply pump		2.2	21	22	
8815	CR20-3	system pump		4.0	21	35	
8816	CR20-4			5.5	21	46	
8876	CR32-2-2	supply pump		3.0	30	23	
8821	CR32-2	system pump		4.0	30	29	
8823	CR32-3-2			5.5	30	38	
8822	CR32-3			5.5	30	43	
8881	CR45-2-2	supply pump		5.5	45	31	
8832		system pump				30	
8831	CR45-2			7.5	45	37	
8886	CR64-1	supply pump		5.5	64	21	
8841		system pump				20	
8843	CR64-2-1			11.0	64	36	
8842	CR64-2			11.0	64	42	
8872	CR15-2	supply pump		60 Hz 3 x 380 – 480 VAC (3 phases, neutral and earth)	3.0	21	32
8813		system pump					29
8814	CR15-3		4.0		21	44	
8874	CR20-2	supply pump	4.0		25	31	
8819		system pump				31	
8818	CR20-3		5.5		25	47	
8877	CR32-1	supply pump	3.0		36	21	
8824	CR32-2-2	system pump	5.5		36	33	
8825	CR32-2		7.5		36	42	
8882	CR45-1-1	supply pump	5.5		54	22	
8834	CR45-1	system pump	7.5		54	27	
8833	CR45-2-2		11.0		54	43	
8887	CR64-1-1	supply pump	7.5		77	21	
8846		system pump				20	
8844	CR64-1		11.0		77	30	

¹⁾Nominal flow (in case of system pump) when using 3 venturis (a standard dosing channel has 1 venturi). With the CR-15, CR-20 and CR-32 pumps, this concerns the venturis of 300 l/h dosing channels with a nozzle of 2.7 mm. With the CR-45 and CR-64 pumps, this concerns 600 l/h dosing channels.

Supply water quality

Composition and pH value

The dosing unit adds acid or lye to the supply water to:

- regulate the pH value of the irrigation water;
- chemically mix (homogenise) the irrigation water in an optimum manner;
- allow a chemical reaction to take place (convert bicarbonate into carbon dioxide).

The pH value of the irrigation water must be between 5.2 and 6.2, depending on the crop and growing medium.

Supply water consists of (a combination of) rain water, drinking water, well water, downstream mill water, river water or reverse osmosis water, typically mixed with (disinfected) drain water. The variety of chemical elements in the supply water determine not only the composition and the pH value of the supply water but also whether or not the supply water can be used as irrigation water once fertiliser and acid or lye have been added using the dosing unit.

Influence of bicarbonate

It is important that the quantity of HCO_3^- (bicarbonate) in the supply water is established by means of water analysis. Bicarbonate has a buffering effect on the pH value and affects the operation of the acid dosing control in the dosing unit:

- An optimum quantity of HCO_3^- in the supply water helps to ensure that plants receive irrigation water with a reliable and accurate pH value via the dosing unit. The correct pH value of the irrigation water is necessary for the good take up of fertilisers by the plant.
- An excessively low quantity of HCO_3^- causes the pH control to become unstable.
- An (excessively) high amount of HCO_3^- leads to an (excessively) slow chemical reaction in the mixing tank. Dosing acid neutralises HCO_3^- , with a quantity of CO_2 (carbon dioxide) being generated. This CO_2 must be released from the irrigation water in the open mixing tank via contact with the ambient air. The greater the quantity of HCO_3^- , the longer before the neutralisation reaction is completed. If the reaction is not completed within the exposure time in the mixing tank, a problem arises: the unit will indeed be supplying irrigation water with the desired pH, but there will still be CO_2 in it. In the closed irrigation line this CO_2 cannot be released into the ambient air, and reaches the plant. There it will be released into the ambient air, causing the pH to rise. In this case, the pH at the plants will not therefore be the same as the pH that was set on the unit.

The table below shows the limit values for the quantity of HCO_3^- and the qualification of the supply water. In some cases, the quantity of HCO_3^- in the water is also displayed as calcium carbonate (CaCO_3), in which case it is usually quoted in mg/l. The corresponding values are included in the table.

Bicarbonate limit values and supply water qualification

Quantity of bicarbonate (HCO_3^-)		Quantity of bicarbonate expressed as calcium carbonate (CaCO_3)		Supply water qualification
[mmol/l]	[mg/l] or [ppm]	[mmol/l]	[mg/l] or [ppm]	
< 0.10	< 6.1	< 0.050	< 5.0	Too low
0.10 – 0.50	6.1 – 30.5	0.050 – 0.250	5.0 – 25.0	Optimum
0.50 – 1.0	30.5 – 61.0	0.250 – 0.5	25.0 – 50	High
≥ 1.0	≥ 61.0	≥ 0.5	≥ 50	Too high

Pre-treat supply water

On the basis of the concentration of HCO_3^- , it must be determined which measures or combinations of measures should be taken to pre-treat the supply water.

Supply water with too low a concentration of bicarbonate

When using reverse osmosis water, but in some cases rain water also, too low a quantity of HCO_3^- (< 0.10 mmol/l) may be deemed to exist in the supply water. Dosing acid may give rise to an unstable chemical reaction in the irrigation water.



This unstable reaction can be stabilised by taking one of the following measures, or a combination thereof:

- Add disinfected drain water, which typically contains bicarbonate, to the supply water (via an EC pre-control).
- Add a small amount of drinking water or spring water (1 – 2%) to the supply water by means of an electric valve with a low flow rate.
- Add a small quantity of bicarbonate to one of the fertiliser solutions. This can be done, for example, by replacing 1% of caustic potash with an equal quantity of potassium carbonate (KHCO_3) or calcium carbonate (K_2CO_3).

Supply water with a high concentration of bicarbonate

When using well water, river water and drinking water, the supply water may sometimes contain a high concentration of HCO_3^- (0.50 – 1.0 mmol/l). Dosing acid may then result in there being insufficient time to neutralise the bicarbonate.



Stabilisation is possible by correcting the pH value of the supply water by accurately dosing a fixed quantity of acid per m^3 of supply water using an acid dosing pump connected to an accurate litre counter.

Preparing an acid supply



Add the acid to the water; never add water to acid.

Determining the correct dilution

The dosing unit often has to dose acid to bring the irrigation water up to the correct pH value. The use of acid depends on:

- the pH of the supply water;
- the desired pH of the irrigation water;
- the nature and concentration of the acid neutralizing compounds in the supply water and in the fertiliser solutions.

In principle, very little acid is required for pH correction. In practice however, there are often substances in the supply water and in the fertiliser solutions which bind the acid (phosphate and bicarbonate). This results in a smaller change in the pH than would be expected based on the quantity of acid applied (this is known as 'buffering'). In order to achieve good pH-control it is therefore important that acid is used in a concentration that has been tailored to the concentration of buffer substances. After all:

- when the acid concentration is too low, even the maximum dosing flow rate will not be sufficient to achieve the desired pH value;
- when the acid concentration is too high, even the smallest possible dosing flow rate will swing the pH value severely and overshoot.

The best practice is to create an acid stock from a dilution of concentrated nitric acid. In order to achieve the optimum dilution, it is necessary to know the quantity of buffer substances in the supply water. Although most laboratory analyses reveal something about this, pre-calculating the precise dilution that is required continues to be problematical. Therefore, in practice the dilution required is determined by starting with a common concentration, for instance 3% (weight percent). If it turns out that the pH is not corrected fully or quickly enough, the concentration must be increased. If it turns out that the pH overshoots and swings dramatically, the concentration must be decreased. In addition, if the quality of the supply water is not constant, the acid concentration must be adjusted every now and then. Always keep a record of which dilution is being used, so that a new acid stock can easily be prepared at the same dilution.



The maximum concentration of (nitric) acid depends on the type of dosing channel used. A higher concentration reduces the service life of the components.

Creating a standard dilution of 3%

Nitric acid is often supplied in 20 l barrels at a concentration of 38%, 53% or 68% (weight percent). To dilute this to 3% (weight percent), it is necessary to mix the contents of the barrel with 315, 470 or 640 l fresh water. Always pour the acid into the water instead of the water into the acid, and always stir the mixture thoroughly to homogenise it.

Example

Make a 3% dilution with a 20 litre barrel of 38% nitric acid:

1. Pour half of the required water into a barrel (e.g. one of 500 l) - in this case 147 litres of water.
2.  Use personal protective equipment to protect your skin and eyes.

Carefully pour the 20 litre barrel of 38% nitric acid into the barrel of water (without splashing or spilling).

3. Also pour the rest of the water, 147 litres, into the barrel.
4. Stir gently with an acid-resistant stirrer so that the acid is mixed well.

With a 20 litre barrel of 38% nitric acid (24.8 kg), 312 litres of 3% nitric acid can be made by first pouring 146 litres of fresh water into a barrel containing sufficient volume, then the 20 litres of nitric acid and then the remaining 146 litres of water.

With a 20 litre barrel of 53% nitric acid (26.7 kg), 470 litres of 3% nitric acid can be made by first pouring 225 litres of fresh water into a barrel containing sufficient volume, then the 20 litres of nitric acid and then the remaining 225 litres of water.

With a 20 litre barrel of 68% nitric acid (28.2 kg), 640 litres of 3% nitric acid can be made by first pouring 310 litres of fresh water into a barrel containing sufficient volume, then the 20 litres of nitric acid and then the remaining 310 litres of water.

Terms and abbreviations



The list below states the abbreviations and terms relating to all disinfection units, purification units and fertiliser dosing units. Therefore, abbreviations and terms that do not apply to your specific unit and as a result are not used in this manual, may still be found in the list below.

Abbreviation / term	Explanation
A+B principle	A principle where fertiliser solutions are prepared manually in 2 (or possibly more) fertiliser tanks, in such concentrations that the unit has to mix them in equal quantities.
ABC principle	A principle where the unit mixes the fertiliser solutions from 3 (or possibly more) fertiliser tanks in the ratios as programmed in the recipe.
Anti-block	Chemical solution to clean the line walls of the distribution system periodically.
(to) Backwash a sand filter	Cleaning of a filter by flushing it with rinse water, against the normal direction of flow, with the dirty rinse water being discharged. Backwashing can periodically be performed automatically using electric valves and a rinse water pump controlled from the process computer.
(to) Backwash	Cleaning a filter by flushing it with rinse water, in counter flow, and draining away the dirty water. Backwashing can be done automatically using electric valves and a rinse water pump that are controlled by the process computer.
Balance level control	Control for the A+B principle that levels any differences in level in the emptying tanks over time. This allows to fill-up the tanks at the same time.
Change-over contact	Switch, switching sensor or relay with 2 positions: normally open (NO) and normally closed (NC). "Normally" refers to the idle position when the component has not been activated.
Direct distribution	The unit carries the irrigation water directly to the crop area and controls the irrigation valves.
Dirt filter	A wide mesh type of filter
(to) Discharge, discharge valve	Discharging irrigation water (e.g. to the sewer) via a (usually manually operated) discharge valve at the beginning of the main irrigation line. This can be necessary if the irrigation water is not of the desired quality (e.g. during the adjustment of the EC and pH controls).
Disinfect (disinfection)	Treating the water in such a way that the (pathogenic) micro-organisms can no longer reproduce. The micro-organisms are not necessarily killed. See also "sterilise".
Disinfected water	Water that has been disinfected by the water disinfection unit.
Drain measurement	Measurement of the volume of drain water over a specific time and of the EC value of the drain water (or measurement of one of both).
Dose	For UV light: the average intensity of the active part of the light to which the water is exposed during the residence time, expressed in mJ/cm ² (intensity (W/cm ²) x time (s) = energy (J/cm ²). In order to produce more easily readable numbers, the figure for the energy is multiplied by 1000 and then expressed as mJ/cm ² . The average intensity is calculated from the intensity measured with the UV sensor, the distance between the UV sensor and the quartz tube, the T10 value determined at the start of the production, the outside diameter of the quartz tube and the inside diameter of the chamber.
Drain water	Water that is not taken up by the plant and is then collected for reuse.
Drive water	Water that flows through the venturi's of the dosing channels to create a vacuum for suctioning fertiliser, or acid or lye solution.
EC	Electrical Conductivity, in the horticultural usually in terms of millisiemens per centimetre (mS/cm).
EC pre-control	Control to mix drain water and fresh water such that the supply water has the desired EC value. This EC value is a base for further increase of the EC value by fertiliser dosing.
Flowsensor	The flow sensor gives a number of pulses per unit of volume passed. The flow sensor is used to measure the volume passing through (flow).
Flash memory	Memory that retains data (such as settings), even after power switch-off or mains voltage failure.
Float switch	Switch installed in a water tank or silo. The float switch transmits a signal when the water reaches the same level as the float. (See also level sensor and level sensor)
(to) Flush, flush valve	Replacing the irrigation water in the main irrigation line by other/new irrigation water (e.g. after changing the recipe). Flushing takes place by opening the flush valve (usually controlled by the process computer) at the end of the main irrigation line and pumping the new irrigation water in the irrigation line.

Abbreviation / term	Explanation
Fresh water	Water having a relative low EC value (no or hardly any fertilisers), such as rain water, groundwater, drinking-water, well water and reversed osmosis water
HBC	High Breaking Capacity, a type of fuse
I/O	Input/Output
I/O module	Module with digital inputs, analogue inputs and/or digital outputs to which sensors, measuring equipment and actuators can be connected.
I/O net	Network where the Connex or Intégro process computer and the I/O modules exchange data.
Imperial	Refers to the British system of units, e.g. for dimensions (e.g. inches). This system is different from the metric system.
Indirect distribution	The unit supplies the irrigation water to a stock tank or silo. From there, a separate system handles the irrigation.
Irrigation water	Water to which fertilisers and acid or lye are added, so that it has the desired EC and pH value.
K-factor	Calibration parameter of a litre counter: the volume (in l) per pulse. This factor is not only determined by the design of the flow sensor, but also by the internal dimensions of the T-piece to which this sensor is screwed and the depth to which the sensor is inserted in the T-piece.
Level sensor	Sensor installed in a water tank or silo. The sensor provides an analogue signal, indicating the water level as a percentage. The level sensor must be calibrated on a regular basis. (See also level switch and float switch)
Level switch	Switch installed in a water tank or silo. The level switch transmits a digital signal when the water reaches a certain level. (See also level sensor and float switch)
Linear light sensor	A type of light sensor to measure sunlight in kilolux (klux) over the visible part of the spectrum (wave length 400 - 800 nm)
Litre counter	See "flowsensor".
Mixing tank level reduction	Anticipating by the process computer on a recipe change by stopping the preparation of new irrigation water on time. This causes the stock in the mixing tank to be used up to the minimum level and the new recipe being available within less time.
Motor protection	Electric protection, based on a thermal working principle, which switches off the (pump) motor when it consumes too much power. The motor protection can be reset after cooling down. The motor protection resides in the cabinet, not on the pump.
Nozzle	The part of a venturi or sprinkler that is responsible for the operation
NTC	Negative temperature coefficient, refers to a type of temperature sensor
P/I	Proportional/Integrating, refers to a type of control where the correction signal consists of a proportional component (correction signal directly proportional to the deviation) and an integrating component (correction signal increases the longer the deviation persists). The control is adjusted by the P and I factors.
pH	degree of acidity (negative logarithm of the concentration of acid particles (H ⁺))
PCB	Printed circuit board
PSD	Programmable system device, a chip into which system software is programmed, amongst other things
Radiation sum	Dose of sunlight (radiation intensity integrated over a period of time, in term of J/m ²) that is received over a specific period of time.
Report alarm/stop alarm	With a report alarm, an alarm is only reported. With a stop alarm, the process is also aborted.
(to) Rinse (a sand filter)	To fill up the sand filter with water so that the sand bed becomes homogeneous and the filter ready for use.
Rotameter	A type of flow meter that is visually readable. A rotameter is based on a float body that is pushed up by the upwards flowing liquid in a transparent tapered pipe.
Sand bed	The layer of sand in a sand filter
Section	Menu or window with settings and/or reports within the use interface of the Connex and Intégro software. The sections are uniquely coded (e.g. <i>I420.5</i> and <i>M430</i>) and the data is arranged in tables with rows (lines) and one or more columns.
Selective disinfection	The reproductive capacity of only some of the types of micro-organisms is disabled (for instance, after selective disinfection fungi and nematodes can no longer multiply, but viruses may still be able to. As long as the corresponding viruses are not harmful to the crop, this is not a problem.) See also "total disinfection".
Settlement of sand filter	Filling a sand filter with water in such a way that the bed of sand is even and the filter is ready for use. The dirt that has come from the bottom of the sand filter after the settlement is transported to the drain water tank.

Abbreviation / term	Explanation
Silo, tank	More or less exchangeable terms for a construction to store liquid or other substances. Silos are constructed from corrugated sheets and are often open at the top. Tanks have smooth walls and can be closed at the top. Silos are often larger than tanks.
Softstarter	Electronic module to run up a (pump) motor in a controlled way, so that electrical and mechanical overload are avoided.
Solarimeter	A type of light sensor to measure sun radiation in W/m ² over a wide spectrum (wavelength 300 .. 2500 nm).
Sterilising	Treating the water in such a way that all micro-organisms are killed. See also "disinfection".
Supply water	Water that flows to the unit. This water consists of fresh and/or drain water.
T10 value	UV permeability of the water to be disinfected over a distance of 10 mm, expressed in a percentage, compared to demineralised water, which is taken as a 100% reference.
Tank	Refer to "Silo, tank".
Total disinfection	The reproduction power of all types of micro-organisms is disabled (for instance, not just of fungi and nematodes but also of viruses). See also "selective disinfection".
UV-C	Ultraviolet light of category C (wavelength 200 – 280 nm)
Valve group	A group of irrigation valves that software opens or closes simultaneous or after each other in an irrigation cycle.
Venturi	A channel with a nozzle that generates a vacuum if drive water flows through. The vacuum causes suctioning of fertiliser, acid or lye solution.
Watchdog	Circuit or software that has to be reset periodically by the running software. If it is not reset then the software 'hangs'. The watchdog then ensures that the software is restarted so the software runs again.
Water hammer	Peak load (by increased pressure) of components of a water system, caused by a sudden standstill or strong direction change of the water flow (e.g. after the fast closure of a valve or after the starting of a pump, when the water 'hammers' against the end of a line that is not bled)

Priva (head office)
Zijlweg 3
2678 LC De Lier
The Netherlands

See www.priva.com for contact information of a Priva office or partner for your region.